

PATIO DR3/DR4

enfilade - dressoir - cabinet

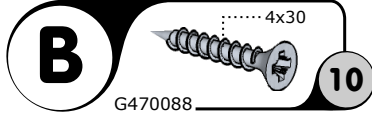

DR3

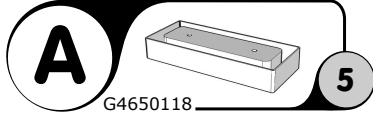
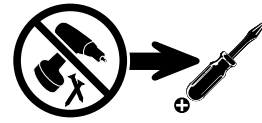
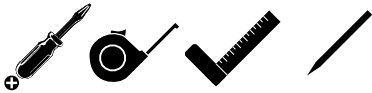
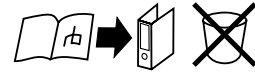
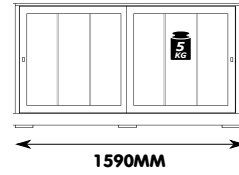

DR4

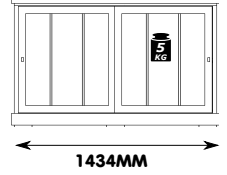

DR3

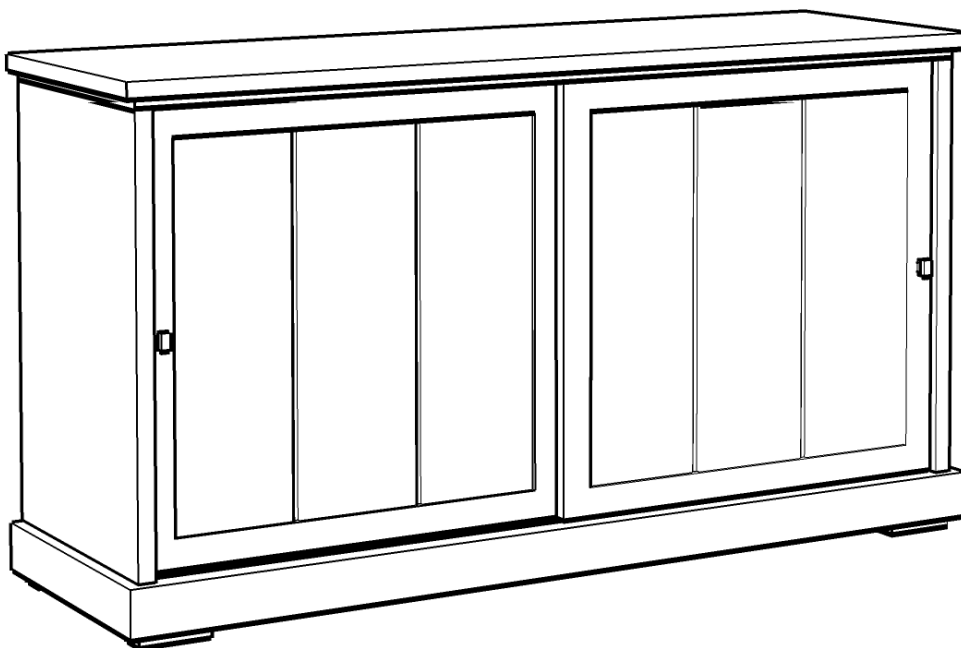

NL**ONDERHOUDSTIPS**

Oppervlakte kunststofdecor houtstructuur. Onderhoud: met lichte vochtige doek reinigen en hierna direct droog wrijven. De meubels zijn niet voor vochtige ruimten (bad, keuken etc.) bestemd. Vocht op het bovenblad direct opnemen. Montagetekening opbergen.

Het meubel moet door een vakkundig persoon, zoals in de handleiding staat beschreven worden gemonteerd. Door verkeerde montage kunnen gevaren ontstaan.

D**HINWEISE FÜR DIE PFLEGE**

Oberflächen Kunststoff-Dekor Holznachbildung. Pflegehinweis: Mit leicht feuchtem Tuch reinigen, sofort trocken nachwischen. Möbel nicht für Feuchträume geeignet (Bad, Küche etc.). Nässe auf Oberfläche unverzüglich wegwischen. Aufbauanleitung aufbewahren.

Das Möbel muss durch eine fachkundige Person entsprechend der Aufbauanleitung montiert werden. Bei fehlerhafter Montage kann es zu Gefahren kommen.

EN**ADVISE ON MAINTENANCE**

All surfaces in laminated wood colour finishes. Maintenance: clean with slightly moistened cloth, wipe dry immediately. Not suited for damp locations (kitchen, bathroom etc.). Wipe off wetness at once. Retain manual instruction.

The unit must be put together by a specialist according to the assembly instructions. Hazards may arise in case of incorrect assembly.

F**CONSEILS D' ENTRETIEN**

Panneaux de particules revêtus d'un film polymère. Entretien: utiliser un chiffon légèrement humide et repasser de suite avec un autre sec. Meuble inadapté aux pièces humides (bain, cuisine etc.). Toute trace de liquide est à essuyer immédiatement. Notice de montage à conserver.

Le meuble doit être monté par une personne spécialisée en la matière, conformément à l'instruction de montage. En cas d'erreur de montage, des dangers peuvent se manifester.

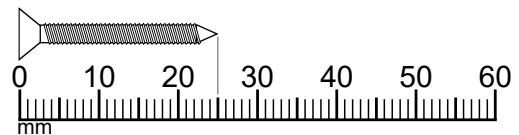
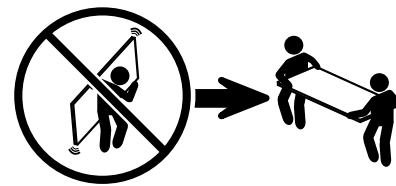
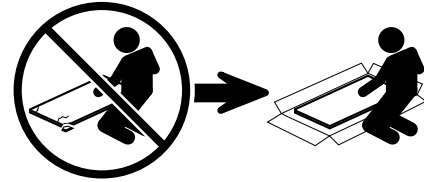
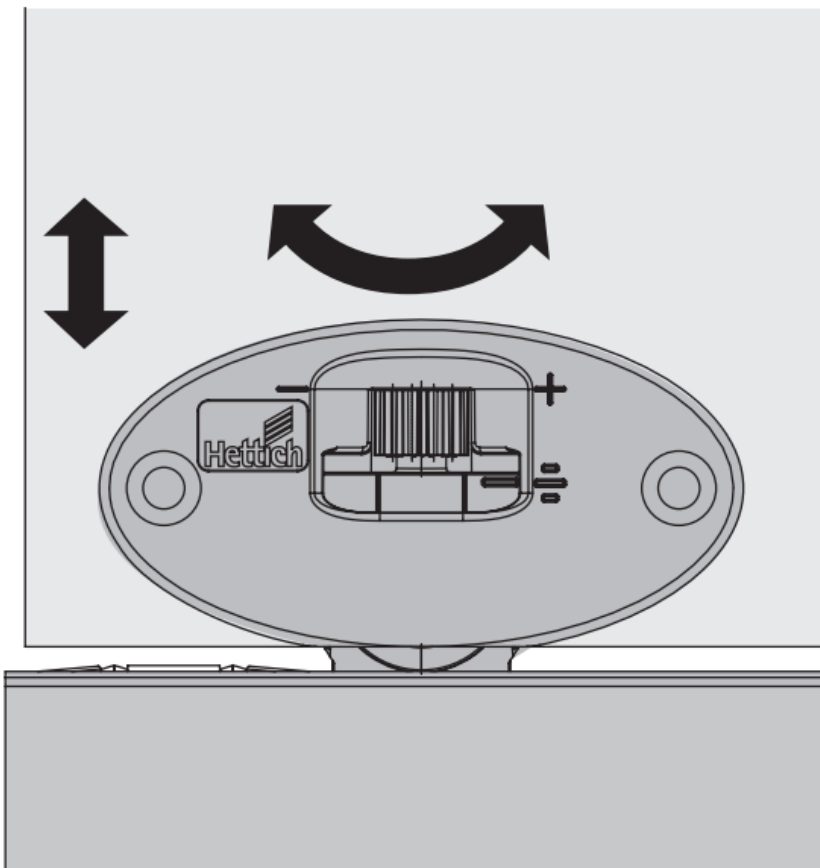
**'DOORS' réglable - regelbaar - adjustable**

ONLINE INSTRUCTION VIDEO



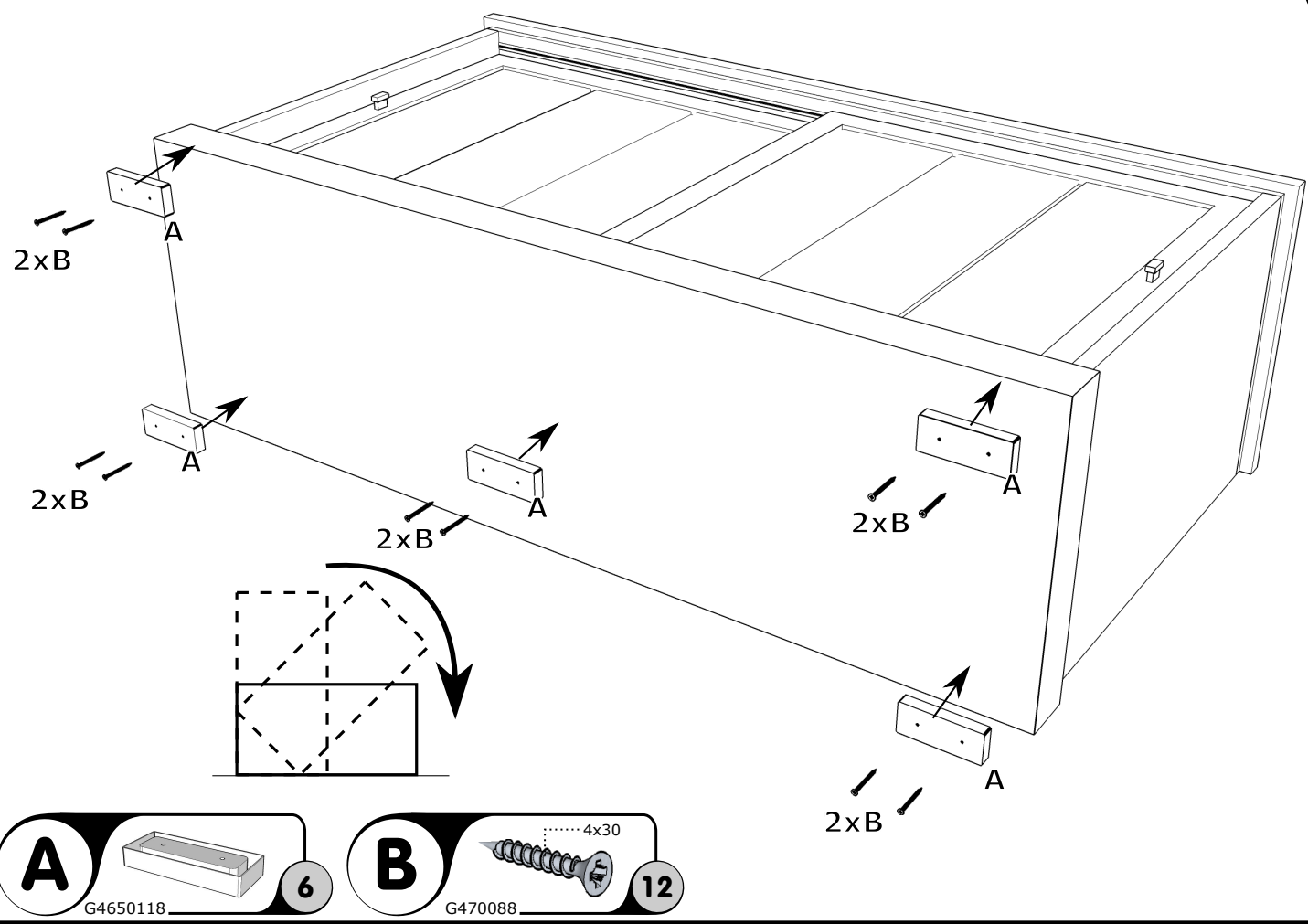

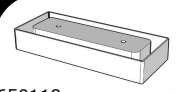
A  6
G4650118

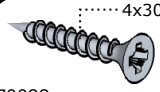
B  12
G470088 4x30

PATIO DR3/DR4

GEGEVENS AANKOPER

INFORMATIONS ACHETEUR - BUYER INFORMATION - KAUFER INFORMATIONEN

WINKEL

MAGASIN - SHOP - GESCHÄFT

PLAATS

LIEU - TOWN - ORT

ORDERBEVESTIGINGSNUMMER

N° DE CONFIRMATION DE LA COMMANDE - ORDER CONFIRMATION N°

KLEUR

COULEUR - COLOR - FARBE

AANKOOPDATUM

DATE DE L'ACHAT - DATE OF PURCHASE - KAUFDATUM

UW REFERENTIE

REFERENCE - REFERENCE - REFERENZ

FACTUURNUMMER

NUMÉRO DE FACTURE - INVOICE NUMBER - RECHNUNGSNUMMER

8

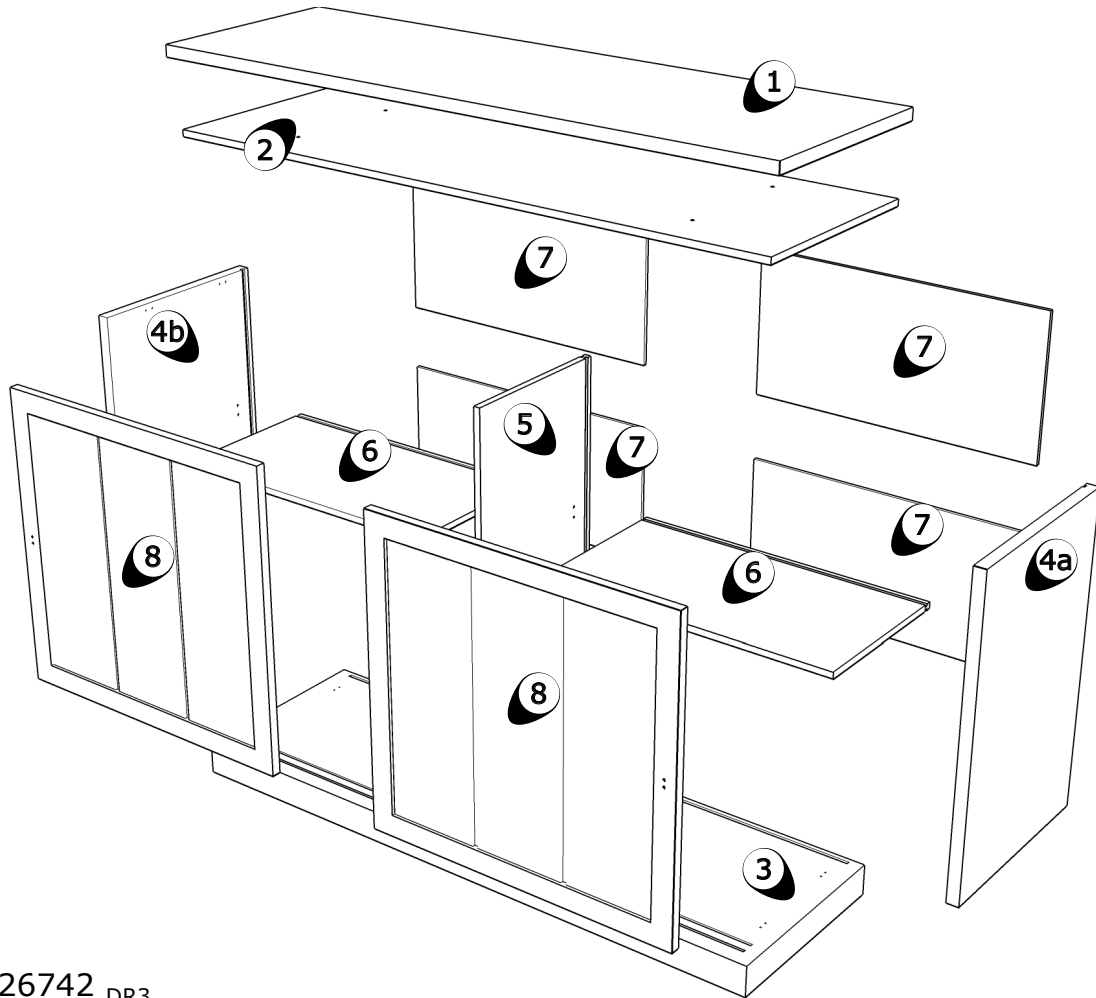
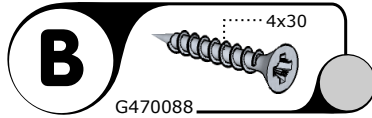
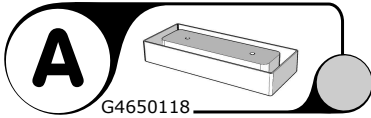

1 T6226742 DR3

1 T6226743 DR4

2 HPATIOBLAD03 DR3

2 HPATIOBLAD04 DR4

3 HPATIOGROND03 DR3

3 HPATIOGROND04 DR4

4 T5226772

5 T5226778

6 T6226782 DR3

6 T6226784 DR4

7 T6226794 DR3

7 T6226796 DR4

8 G4807898 DR3

8 G4807899 DR4

TOELICHTING EXPLICATIONS - EXPLANATION - ERKLÄRUNG