

notice de montage
Lit 140/160 **VERTIGO**

**ITALIANO****CONSIGLI DI MONTAGGIO:**

- Studiare bene le istruzioni di montaggio.
- Prendere conoscenza dei pezzi che costituiscono il mobile.
- Raggruppare e controllare la ferramenta.
- Munirsi degli utensili necessari.
- Preparare una zona di montaggio
- Procedere al montaggio

AVVERTENZA

NON FORZARE MAI GLI ASSEMBLAGGI. RISTRINGERE LE VITI DOPO UN PERIODO D'USO. CONSERVARE QUESTE ISTRUZIONI DI MONTAGGIO. SE UN PEZZO VENISSE A MANCARE SAREBBE IL MIGLIORE MEZZO DI COMUNICAZIONE CON IL RIVENDITORE.

CONSIGLI PER LA MANUTENZIONE:

E' sufficiente spolverare regolarmente con un panno asciutto, morbido e pulito, preferibilmente nella direzione del disegno. Le macchie possono essere eliminate con un panno leggermente umido; in ogni caso asciugare subito. Non usare in nessun caso cera, olio, spray per mobili e prodotti chimici.

ESPAÑOL**CONSEJOS PARA EL MONTAJE:**

- Studiare bene le istruzioni di montaggio.
- Prendere conoscenza dei pezzi che costituiscono il mobile.
- Raggruppare e controllare la ferramenta.
- Munirsi degli utensili necessari.
- Preparare una zona di montaggio
- Procedere al montaggio

ADVERTENCIA

NUNCA FUERCE LOS ENSAMBLAJES. APRIETE LOS TORNILLOS DESPUÉS DE UN PERÍODO DE USO. MANTENGA ESTAS INSTRUCCIONES DE MONTAJE. SI FALTA UNA PIEZA SERÍA EL MEJOR MEDIO DE COMUNICACIÓN CON EL DISTRIBUIDOR.

CONSEJOS PARA EL MANTENIMIENTO:

Es suficiente espolvorear regularmente con un paño seco, suave y limpio, preferiblemente en la dirección del dibujo. Las manchas se pueden quitar con un paño ligeramente húmedo; en cualquier caso, secar de inmediato. Nunca use cera, aceite, spray para muebles y productos químicos.

FRANÇAIS**CONSEILS DE MONTAGE:**

- Bien etudier la notice de montage.
- Reperez les pieces constituant votre meuble, constituiscono il mobile.
- Regroupez et controlez la quincaillerie.
- Munissez-vous de l'outillageneccesaire.
- Amenez-vous une zone de montage.
- Procédez au montage.

AVERTISSEMENT

NE JAMAIS FORCER LES ASSEMBLAGES. RESSERREZ LES VIS APRES QUELQUES TEMPS D'USAGE. GARDER VOTRE NOTICE DE MONTAGE, SI UNE PIECE VENAIT A MANQUER, ELLE SERAIT LE PLUS CLAIR MOYEN DE COMMUNIQUER AVEC VOTRE MAGASIN.

CONSEILS D'ENTRETIEN:

Enlevez régulièrement la poussière avec un chiffon propre, doux et sec, en suivant la structure du dessin. Les taches s'enlèvent avec un tissu légèrement humide, puis séchez la surface immédiatement. N'utilisez jamais de la cire, de l'huile, du vaporisant meuble ou des produits d'entretien contenant de produits chimiques.

ENGLISH**ASSEMBLY ADVICE:**

- Carefully read the assembly instruction.
- Identify the components of the furniture.
- Group and check the hardware.
- Use the required tools.
- Create an assembly zone.
- Make the assembly.

WARNING

NEVER FORCE THE CONNECTIONS. RE-TIGHTEN THE SCREWS AFTER FEW DAYS. PLEASE RETAIN THE AI LEAFLET FOR FUTURE REFERENCE. THE AI CONTAINS INFORMATION WHEN CLAIMING FOR MISSING PARTS.

CLEANING ADVICE:

Regularly dust with a clean soft dry cloth following the direction of the foil imprints. Stains should be removed using a damp cloth. The area should be dried off straight after cleaning. Do not use wax, oils, furniture spray or any cleansing agents containing chemicals.

DEUTSCH**MONTAGE ANLEITUNG:**

- Die montageanleitung sorgfältig durchlesen.
- Die einzelteile des mobilstücks ermitteln.
- Die beschläge zusammenlegen und prüfen.
- Das notwendige werkzeug zurechtlegen.
- Einen montagebereich freimachen.
- Das mobilstück zusammenbauen.

ACHTUNG

NIEMALS DIE VERBINDUNGEN ZU STARK ANZIEHEN. DIE SCHRAUBEN NACH EINIGER ZEIT DES GEBRAUCHS ERNEUT FESTZIEHEN. DIE MONTAGEANLEITUNG GUT AUFBEWAHREN: SOLLTE EIN TEIL FEHLEN, ISTSIE DAS BESTE VERSTÄNDIGUNGSMITTEL MIT IHREM GESCHAFT.

PFLEGEHINWEISE:

Es reicht aus, regelmäßig mit einem trockenen, weichen und sauberen Tuch zu stäuben, vorzugsweise in Zeichenrichtung. Flecken können mit einem leicht feuchten Tuch entfernt werden. In jedem Fall sofort trocknen. Verwenden Sie niemals Wachs, Öl, Möbelspray oder Chemikalien.

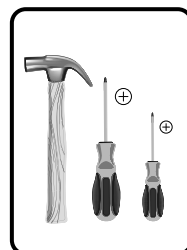
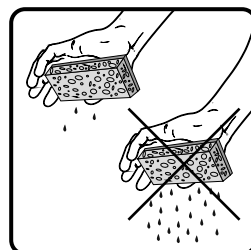
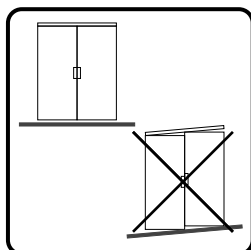
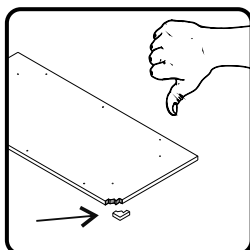
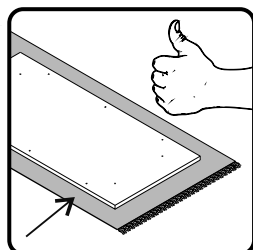

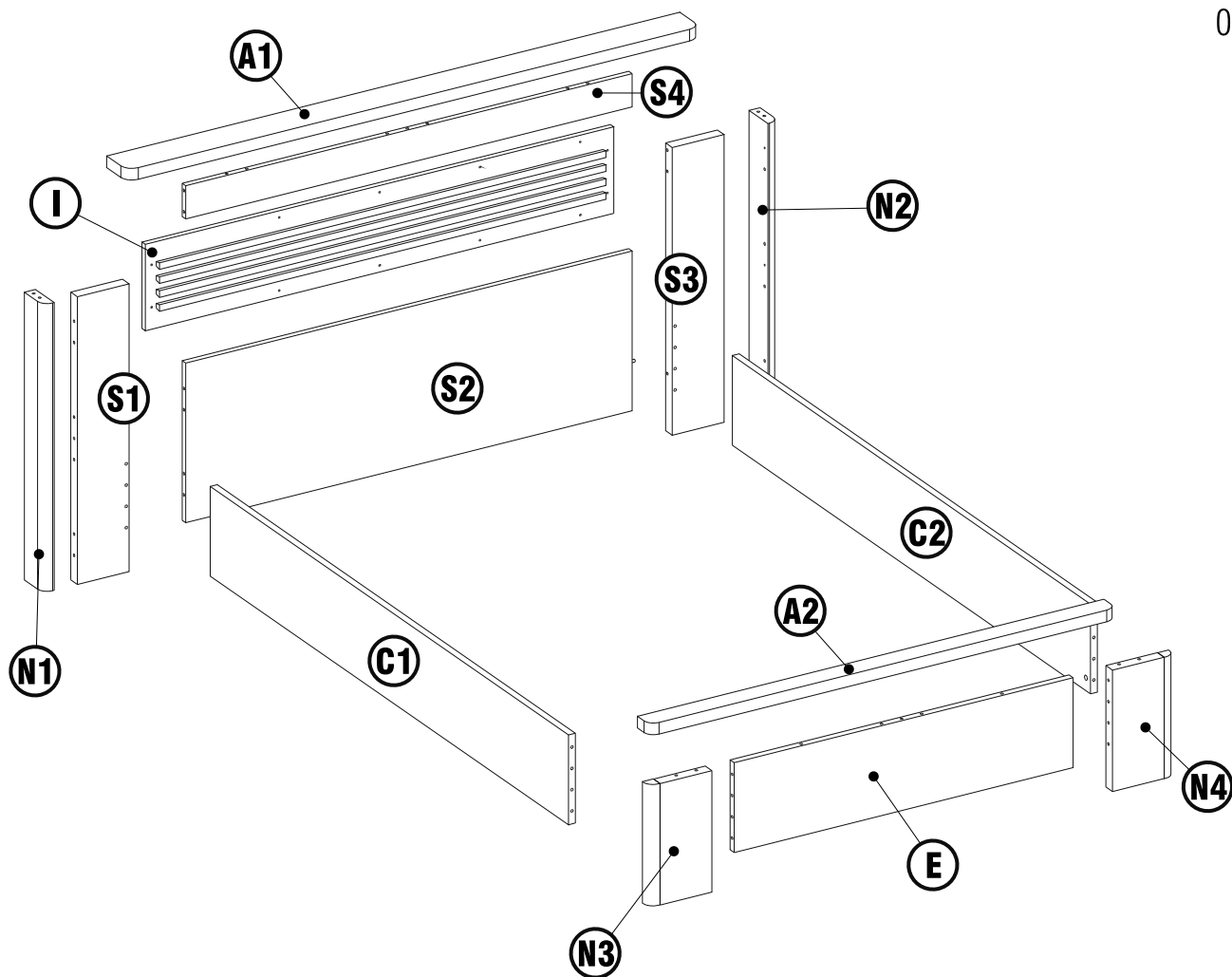

Lit 140

	N°	mm	package
(A1)	x1	1828x110x35	1/3
(A2)	x1	1488x65x35	1/3
(C1)	x1	1900x270x22	3/3
(C2)	x1	1900x270x22	3/3
(E)	x1	1081x270x35	2/3
(I)	x1	1494x260x18	3/3
(N1)	x1	100x35x865	2/3
(N2)	x1	100x35x865	2/3
(N3)	x1	35x35x365	2/3
(N4)	x1	35x35x365	2/3
(S1)	x1	865x165x35	1/3
(S2)	x1	1424x480x18	1/3
(S3)	x1	865x165x35	1/3
(S4)	x1	1424x100x18	1/3

Lit 160

	N°	mm	package
(A1)	x1	2028x110x35	1/3
(A2)	x1	1688x65x35	1/3
(C1)	x1	1900x270x22	3/3
(C2)	x1	1900x270x22	3/3
(E)	x1	1281x270x35	2/3
(I)	x1	1694x260x18	3/3
(N1)	x1	100x35x865	2/3
(N2)	x1	100x35x865	2/3
(N3)	x1	35x35x365	2/3
(N4)	x1	35x35x365	2/3
(S1)	x1	865x165x35	1/3
(S2)	x1	1624x480x18	1/3
(S3)	x1	865x165x35	1/3
(S4)	x1	1624x100x18	1/3

301 x42



8x30

307 x4



L.70mm

325 x4



326 x8

352 x14



356 x14



M4x25

414 x16



6MAx15

cod.807500747

390 x1



cod.814120010

303 x34



15

313 x14



411 x4



322 x8



cod.807500749

413 x4

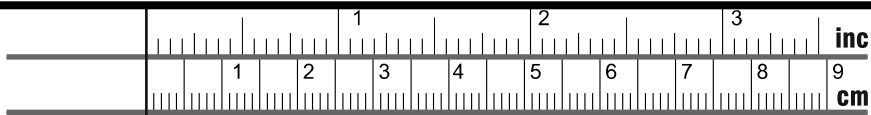

352



356

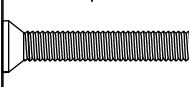

301

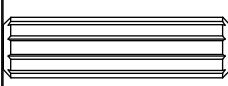

411

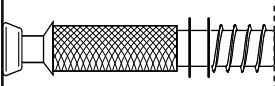

313

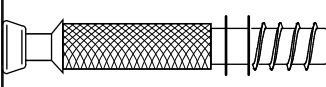

322

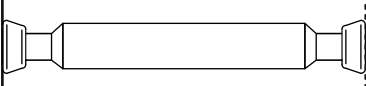

307

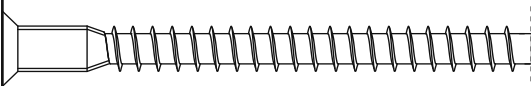

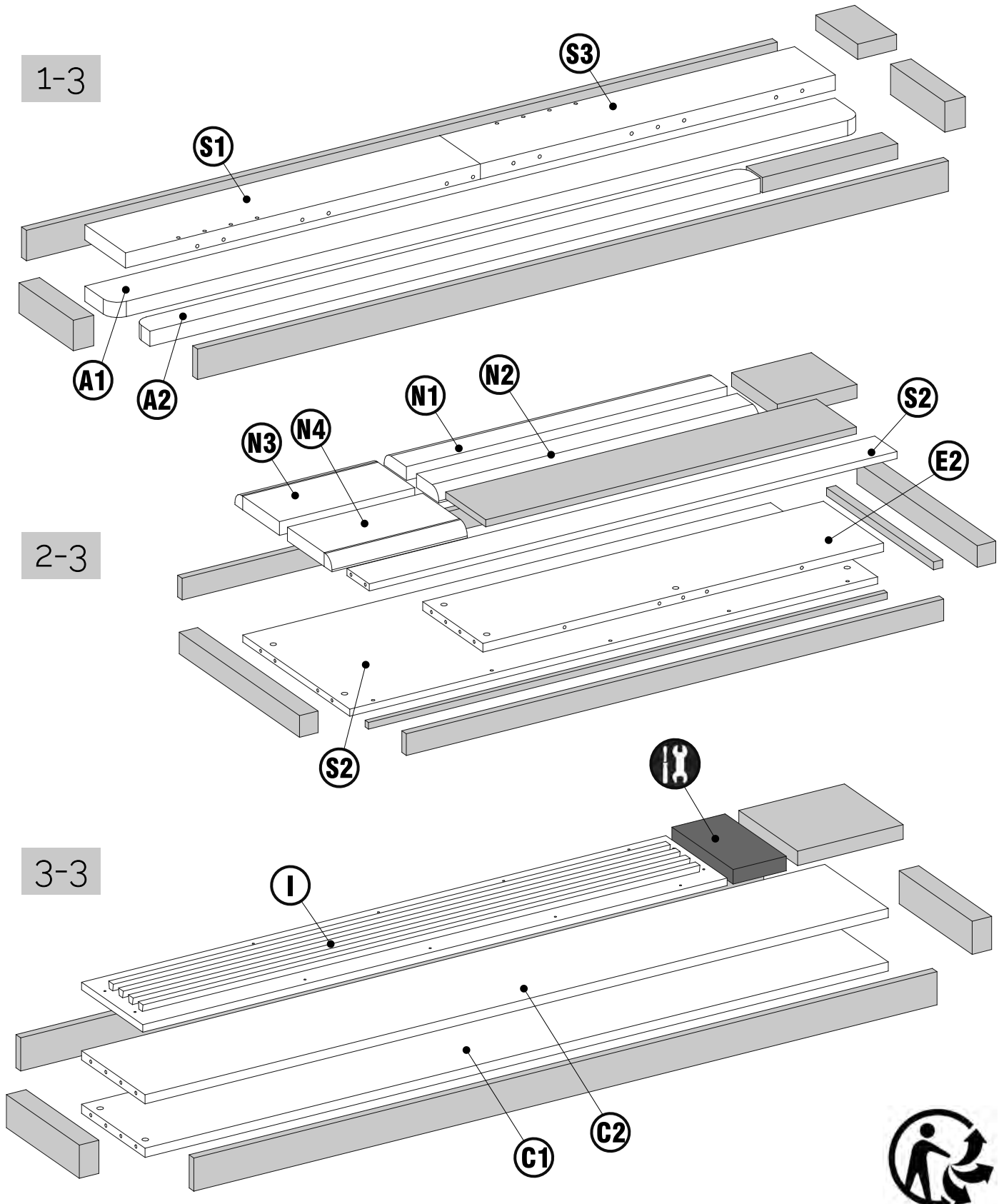

Package total

3 colis

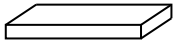
Package 1/3 Kg.31 Package 2/3 Kg.39 Package 3/3 Kg.27	N°3 
---	---

**UTILISER UN CHIFON
 DOUX LEGEREMENT
 HUMIDIFIE' NE PAS
 UTILISER DE PRODUITS
 DETERGENTS OU
 ABRASIFS**



