









# ASSEMBLY INSTRUCTION

Item NO: 1011

HARDWARE LIST			
NO.	PART	DESCRIPTION	Q'TY
A		board	2
B		frame	4
C		Transom 1	4
D		Transom 2	2
E		screw	24
F		allen key	1
G		nail	8
H		feet	8

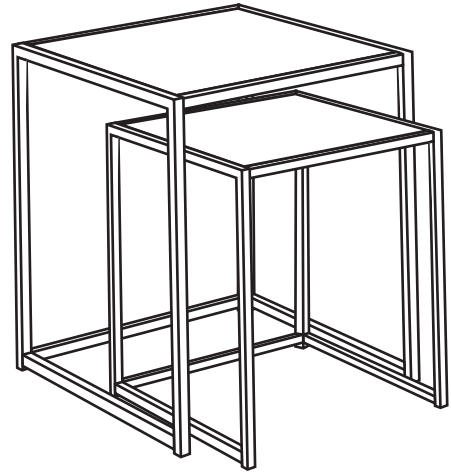

Assembled process of the two tables are same, each part has a small one a big one.

step 1 step 2

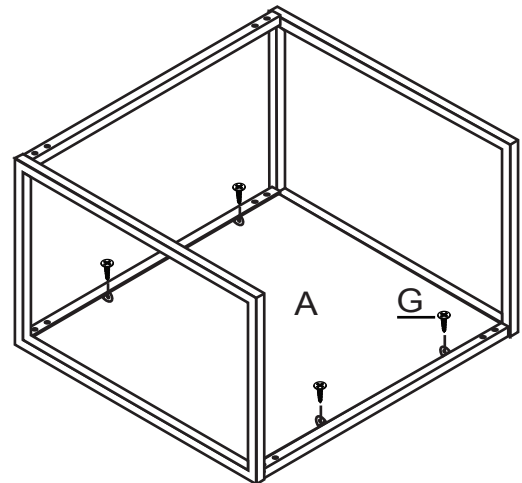
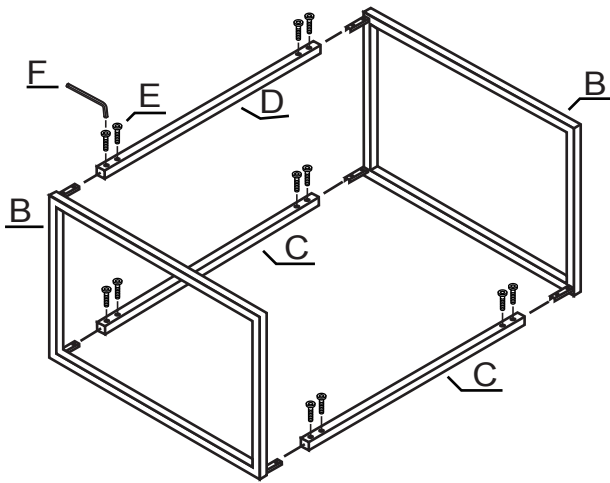

step 3 step 4

