

# RUSH

INDICE B

RUSH 4405 TABLE RECTANGULAIRE PIED CENTRAL N°13 Réf: 18SB2739

**NOTICE DE MONTAGE**  
ASSEMBLING INSTRUCTIONS  
MONTAGEANLEIUNG  
MANUAL DE MONTAJE  
MONTAGEVOORSCHRIFT  
INSTRUÇÕES DE MONTAGEM  
ISTRUZIONI DI MONTAGGIO  
ИНСТРУКЦИЯ ПО СБОРКЕ  
Naputci za montažu

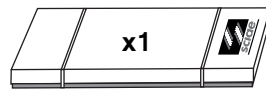
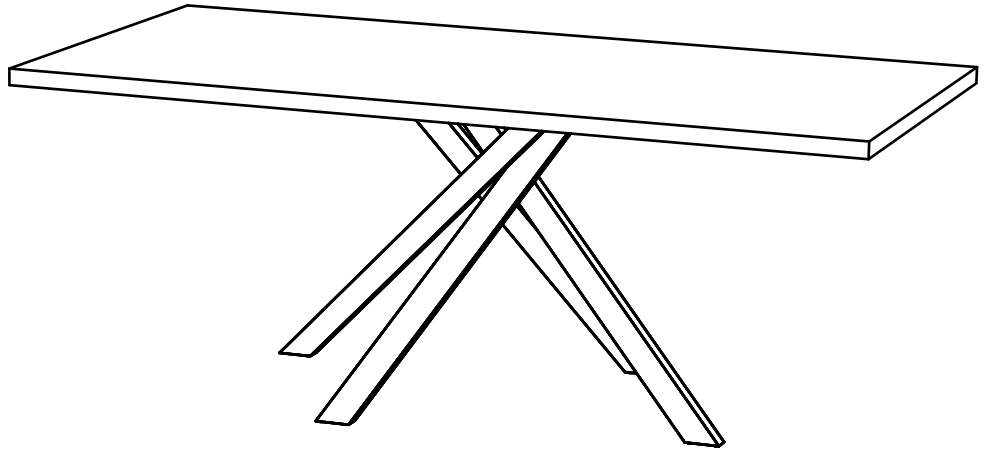

Package 1: 55 Kg

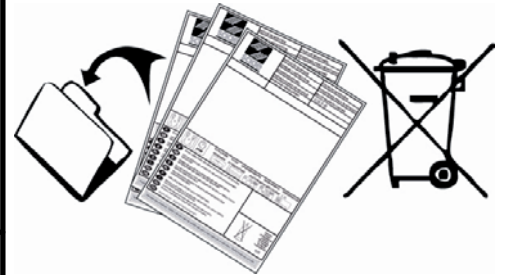

**F** POUR L'APRES-VENTE, RETOURNEZ AU MAGASIN AVEC CETTE NOTICE

**GB** FOR THE AFTER SALES, GO BACK TO THE SHOP WITH THIS ASSEMBLY INSTRUCTION

**D** WENDEN SIE SICH BITTE AN IHREN HANDLER UND GEBEN SIE IHM DIE KENNUMMER DES MOBELS UND DIE TEILNUMMER

**E** EN CASO DE SERVICIO POST-VENTA DEBEN DE VOLVER A LA TIENDA CON LAS INSTRUCCIONES DE MONTAJE

**NL** VOOR SERVICE NA VERKOOP, GA NAAR UW LEVERANCIER MET DEZE MONTAGE HANDLEIDING

**P** PARA O POS VENDA, VOLTE A LOJA COM ESTA FOLHA

**I** SERVIZIO POST VENDITA: E NECESSARIO PRESENTARSI SUL PUNTO VENDITA CON QUESTE ISTRUZIONI DI MONTAGGIO

**RU** ДЛЯ ПОСЛЕПРОДАЖНОГО ОБСЛУЖИВАНИЯ ПРОСЬБА ОБРАТИТЬСЯ В МАГАЗИН ПРЕДЪЯВИВ НАСТОЯЩУЮ ИНСТРУКЦИЮ ПО СБОРКЕ

**HR** U SLUČAJU REKLAMACIJE, VRATITE SE NA PRODAJNO MJESTO S OVIM UPUTAMA ZA MONTAŽU

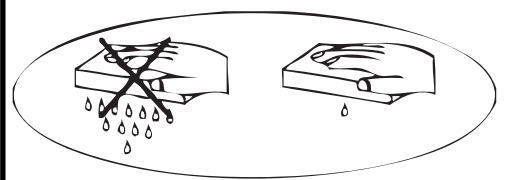



	+40°C +104°F	
	<p>HYGROMETRIE HYGROMETRY</p> <p>40%-65%</p>	
	+15°C +59°F	

1 an  
1 year

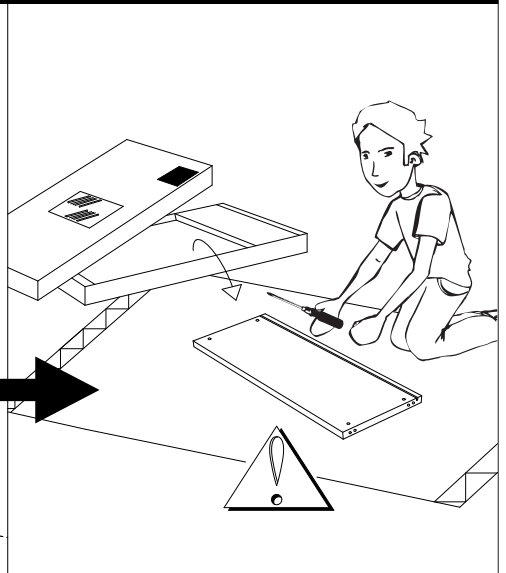
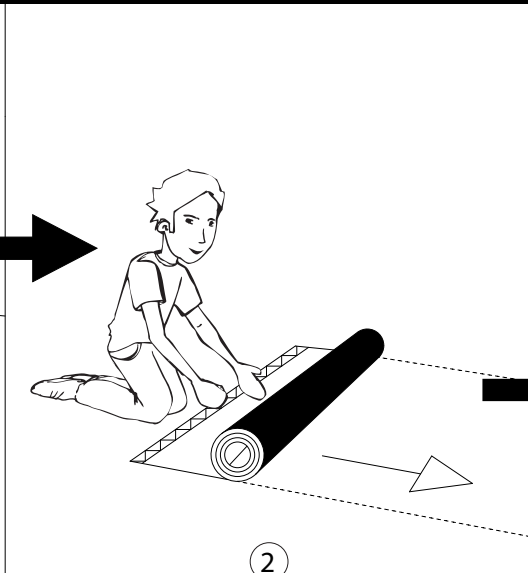
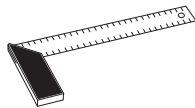
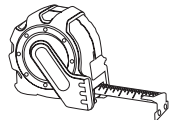
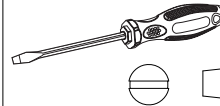
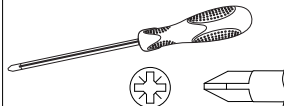
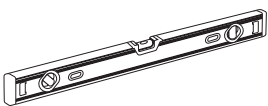
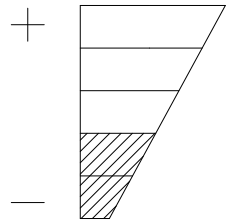
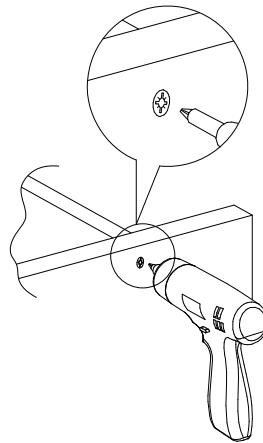
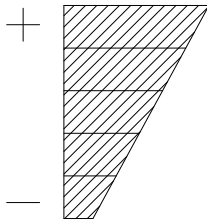
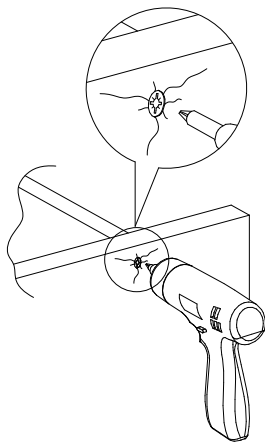
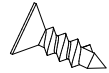
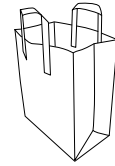
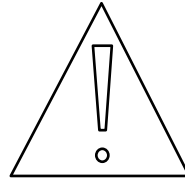
OK

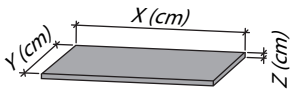
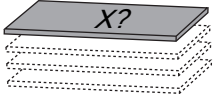
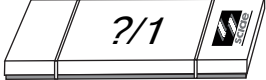

<i>DESIGNATION</i>		N°		
Plateau	200 x 100 x 3.8	1		1

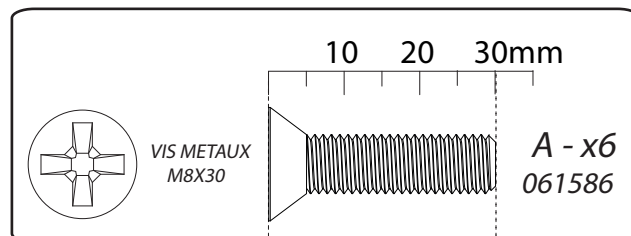

1

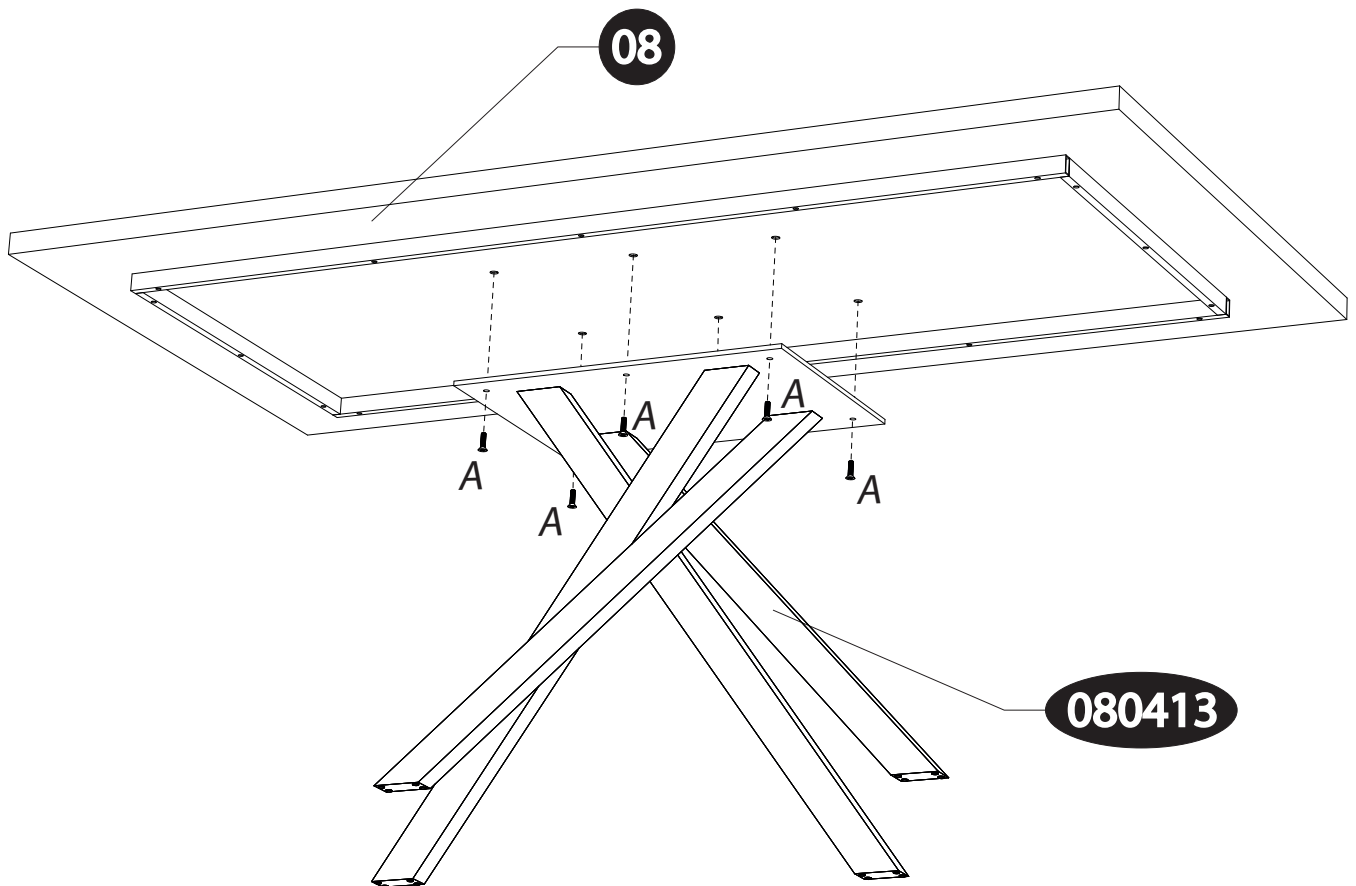
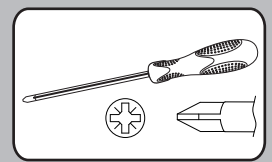
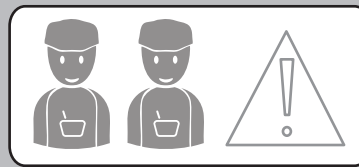
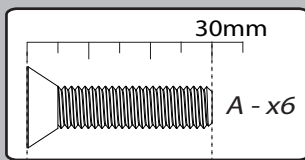

#### RUSH 4405:

Table rectangulaire pied central composé de panneaux de particules revêtus papier décor chêne piètement métal noir.

L.200 cm - H.75 cm - P.100 cm.

A monter soi-même.

#### FRANCAIS

##### Recommandations de démontage :

En cas de déménagement, il convient de procéder au démontage de votre meuble, en ôtant toute la visserie.

#### ENGLISH

##### Disassembly advices:

In case of moving, it is needed to dismantle the furniture removing the fittings.

#### DEUTSCH

##### Empfehlungen für die Demontage:

Bei Transport bitte alle Beschläge demontieren.

"Les meubles contenant des panneaux à base de bois (panneaux de particules, panneaux de fibres, contreplaqué...) peuvent émettre des substances polluantes dans l'air intérieur. Il est ainsi recommandé, après l'installation du meuble dans son logement, d'aérer fréquemment la pièce concernée pendant au moins quatre semaines afin de réduire son exposition aux polluants émis par le meuble."