

# RUSH

## INDICE D

RUSH 4405 VITRINE 1PB 1PG N°20 Réf: 18SB4020

**NOTICE DE MONTAGE**  
ASSEMBLING INSTRUCTIONS  
MONTAGEANLEIUNG  
MANUAL DE MONTAJE  
MONTAGEVOORSCHRIFT  
INSTRUÇÕES DE MONTAGEM  
ISTRUZIONI DI MONTAGGIO  
ИНСТРУКЦИЯ ПО СБОРКЕ  
Naputci za montažu

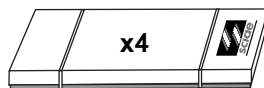
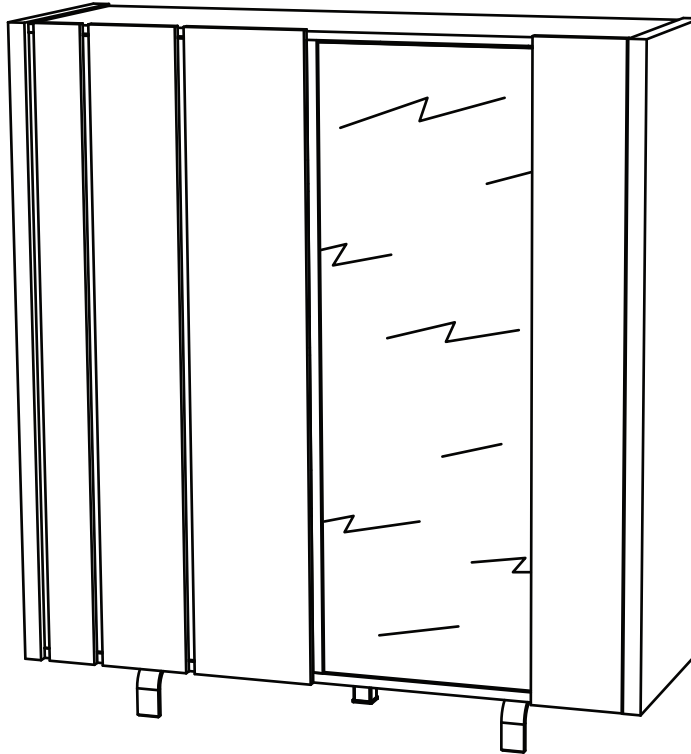

Package 1: 21 Kg    Package 2: 31 Kg  
Package 3: 35 Kg    Package 4: 22 Kg

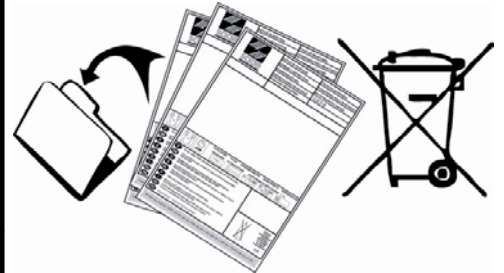

**F** POUR L'APRES-VENTE, RETOURNEZ AU MAGASIN AVEC CETTE NOTICE

**GB** FOR THE AFTER SALES, GO BACK TO THE SHOP WITH THIS ASSEMBLY INSTRUCTION

**D** WENDEN SIE SICH BITTE AN IHREN HANDLER UND GEBEN SIE IHM DIE KENNUMMER DES MOBELS UND DIE TEILNUMMER

**E** EN CASO DE SERVICIO POST-VENTA DEBEN DE VOLVER A LA TIENDA CON LAS INSTRUCCIONES DE MONTAJE

**NL** VOOR SERVICE NA VERKOOP, GA NAAR UW LEVERANCIER MET DEZE MONTAGE HANDLEIDING

**P** PARA O POS VENDA, VOLTE A LOJA COM ESTA FOLHA

**I** SERVIZIO POST VENDITA: E NECESSARIO PRESENTARSI SUL PUNTO VENDITA CON QUESTE ISTRUZIONI DI MONTAGGIO

**RU** ДЛЯ ПОСЛЕПРОДАЖНОГО ОБСЛУЖИВАНИЯ ПРОСЬБА ОБРАТИТЬСЯ В МАГАЗИН ПРЕДЬЯВИВ НАСТОЯЩУЮ ИНСТРУКЦИЮ ПО СБОРКЕ

**HR** U SLUČAJU REKLAMACIJE, VRATITE SE NA PRODAJNO MJESTO S OVIM UPUTAMA ZA MONTAŽU

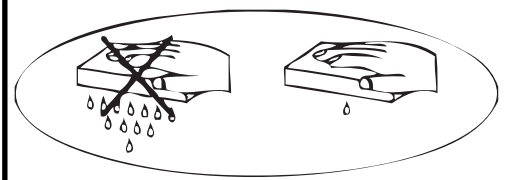

	+40°C +104°F	
	HYGROMETRIE HYGROMETRY 40%-65%	
	+15°C +59°F	

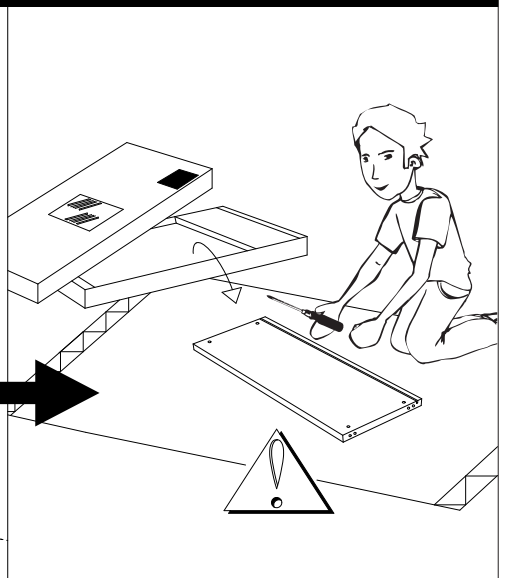
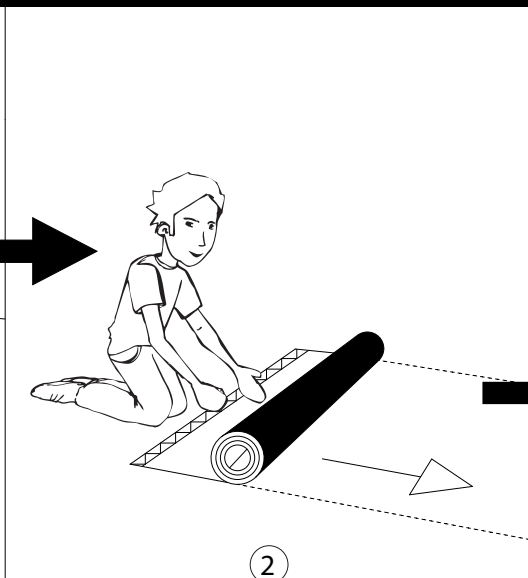
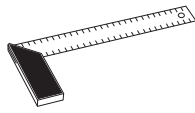
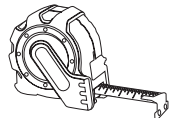
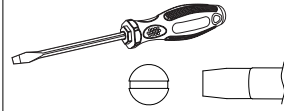
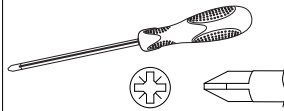
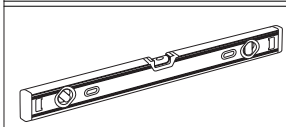
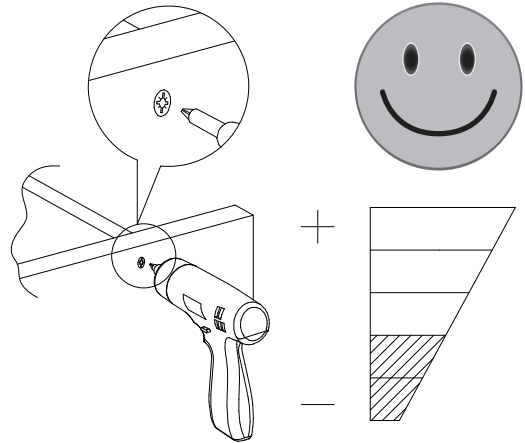
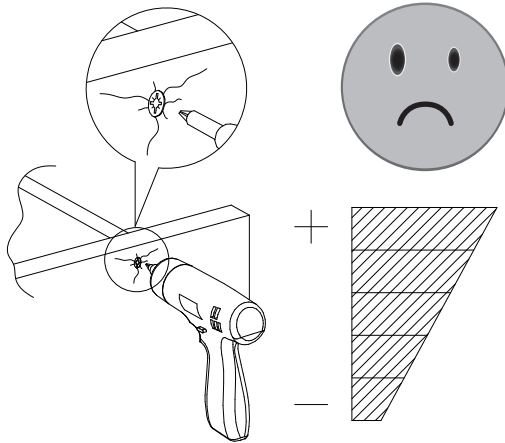
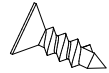
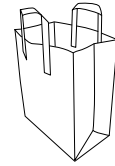
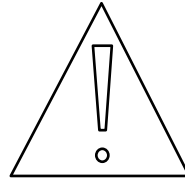

	1 an 1 year		

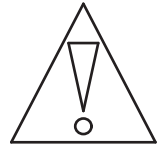
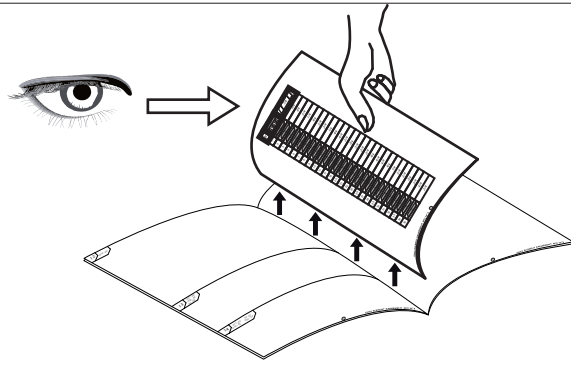

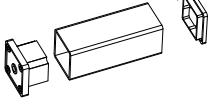

1

L - x3



M - x2



20mm

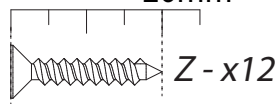

30mm

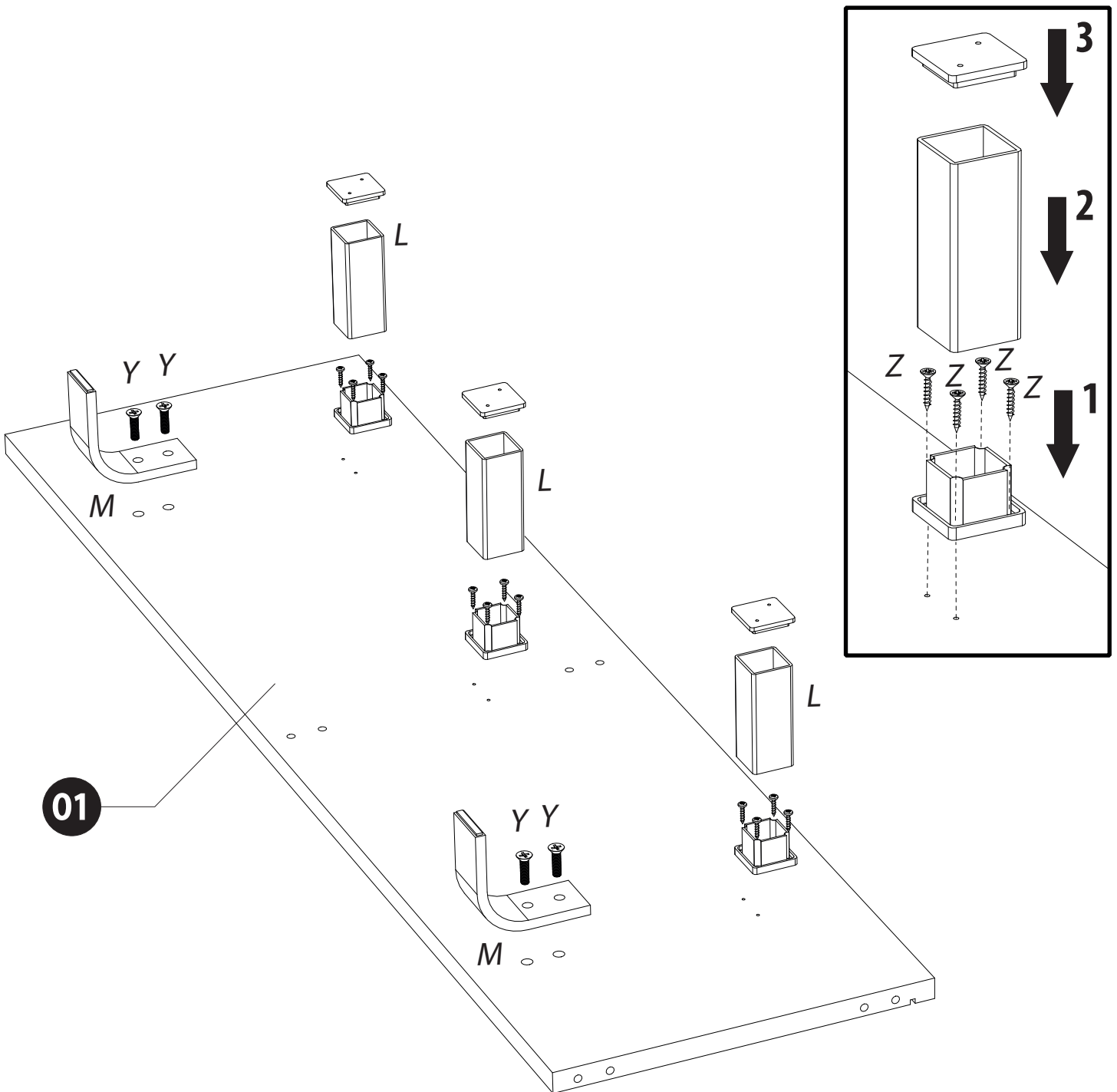
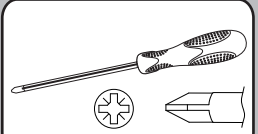
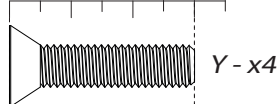

01

2

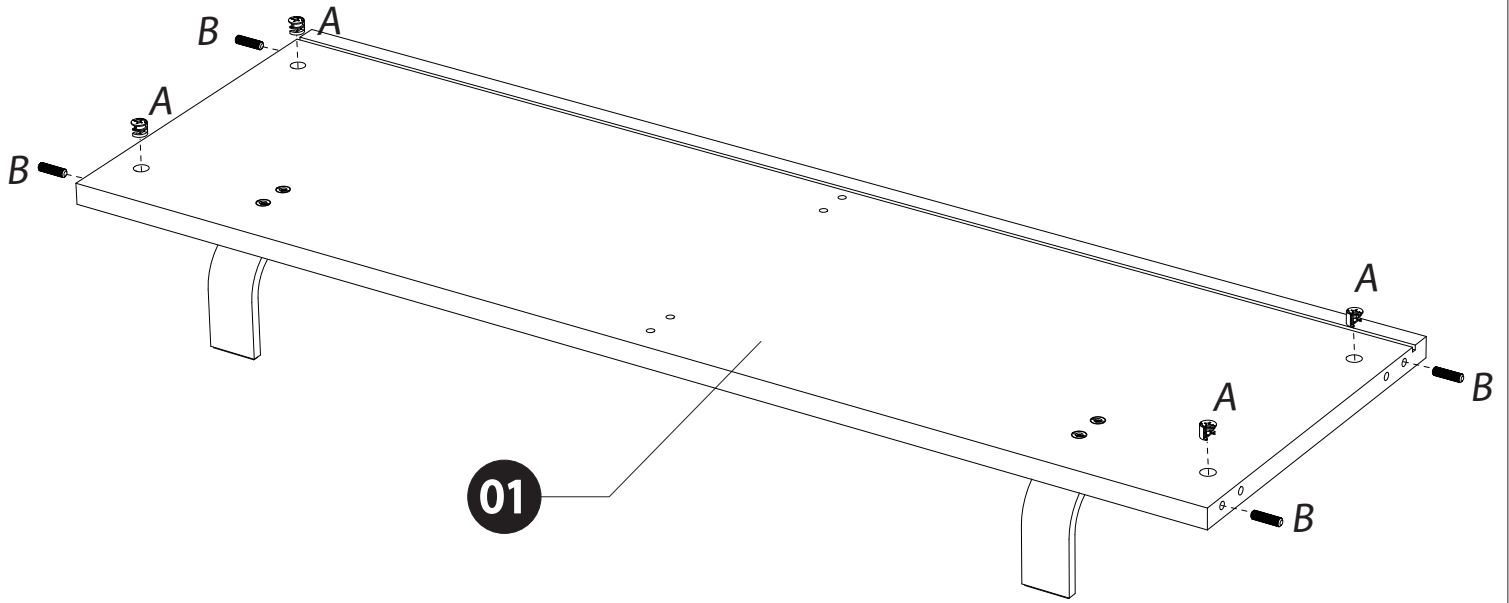
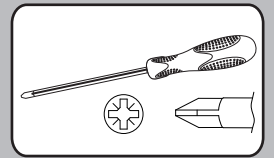
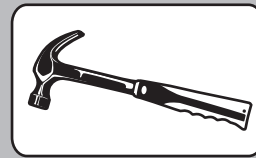
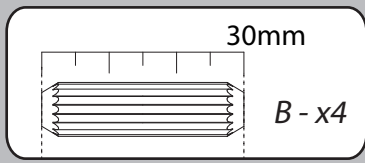
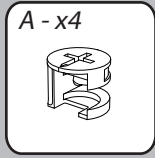

3

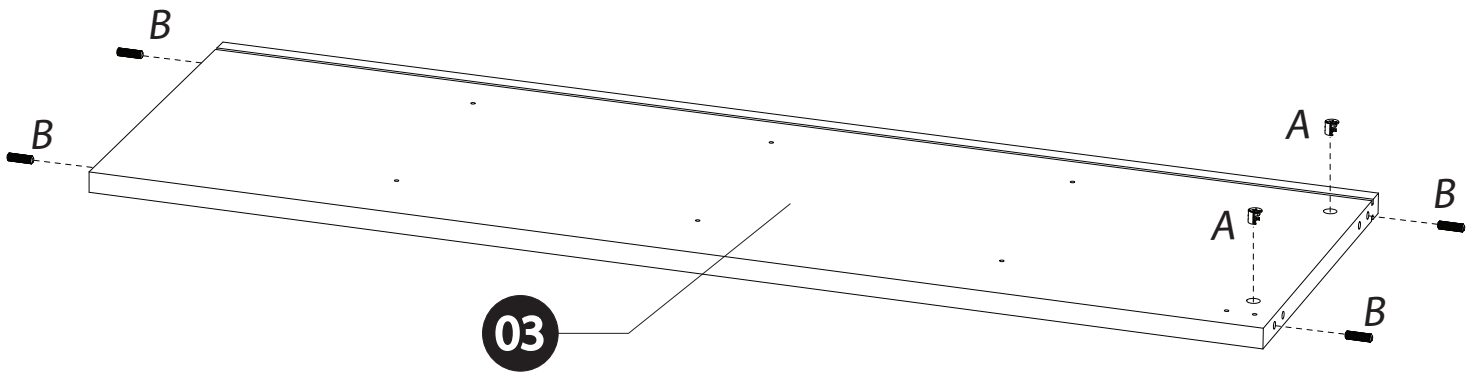
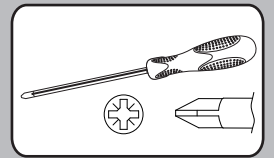
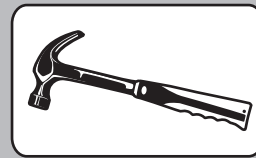
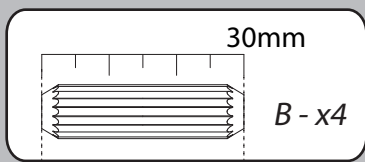
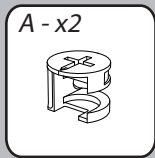

4

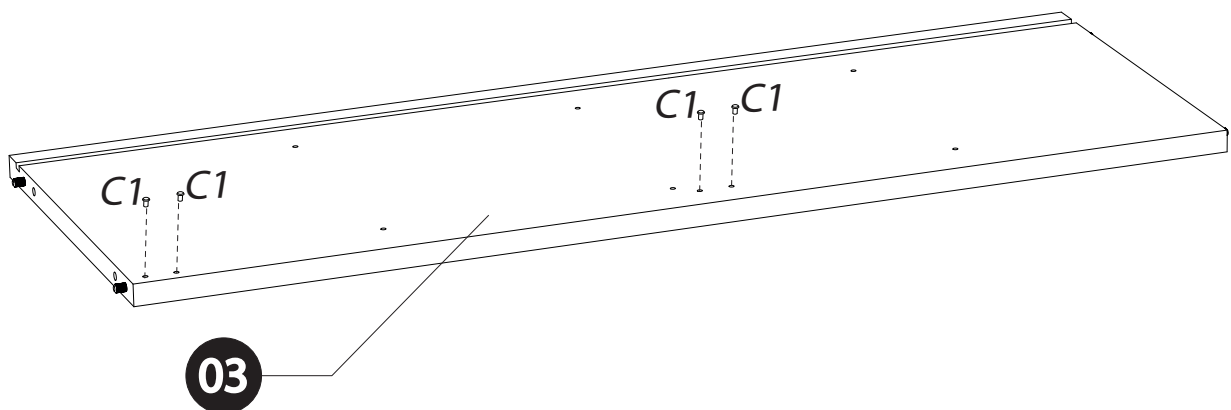
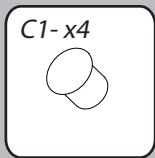

5

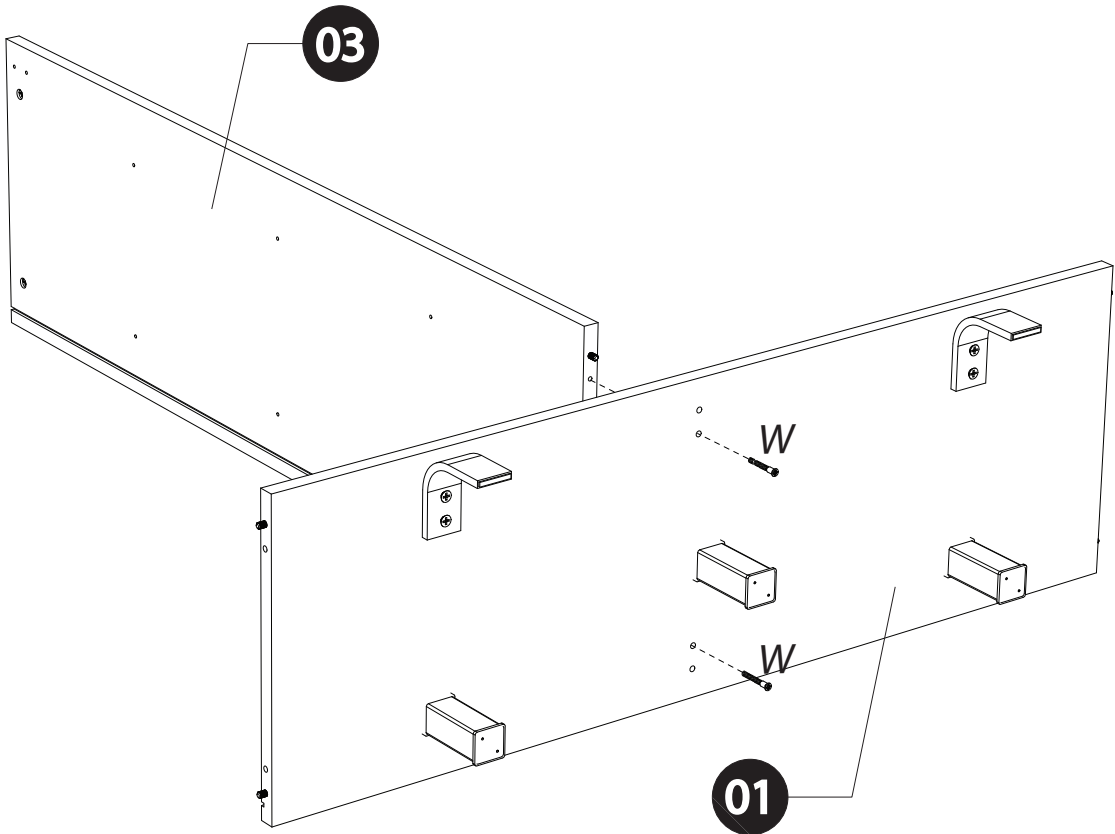
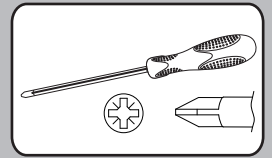
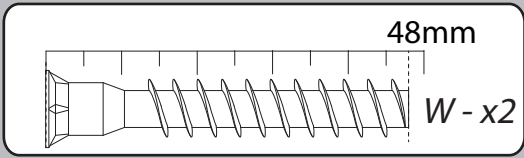

6

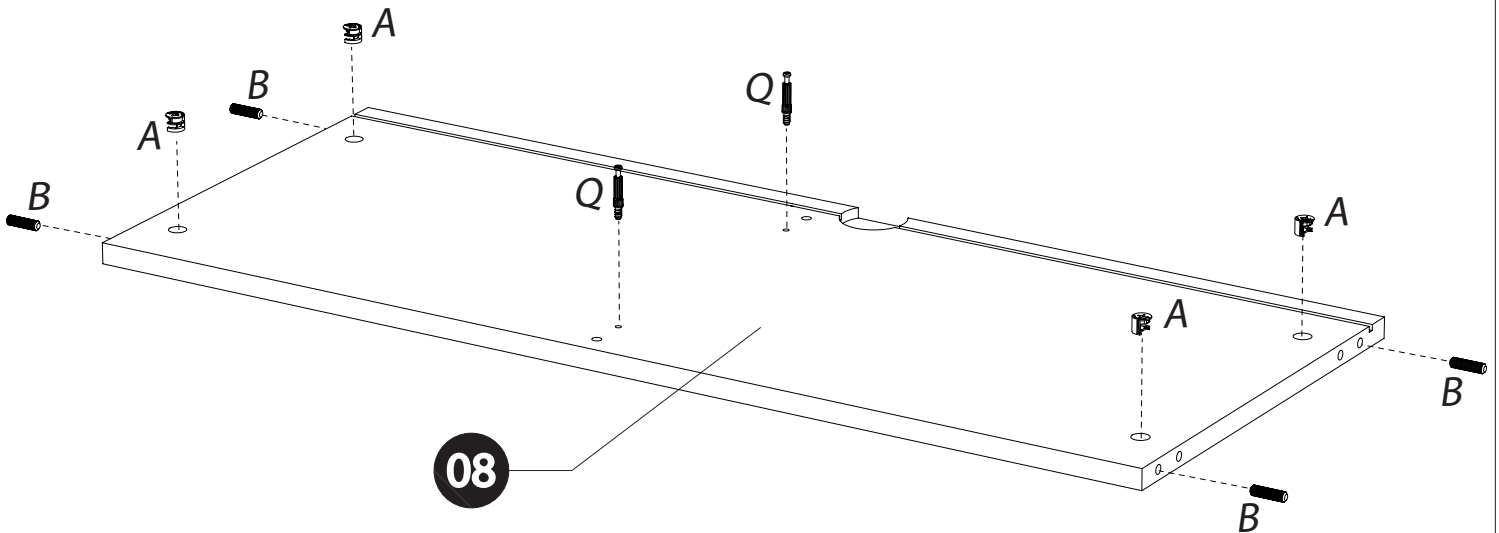
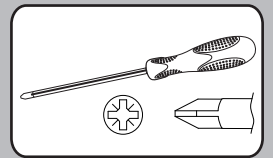
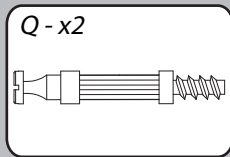
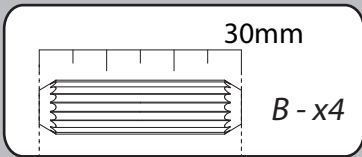
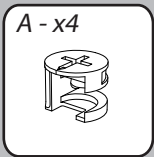

# 7

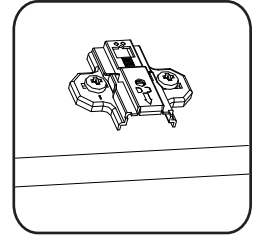
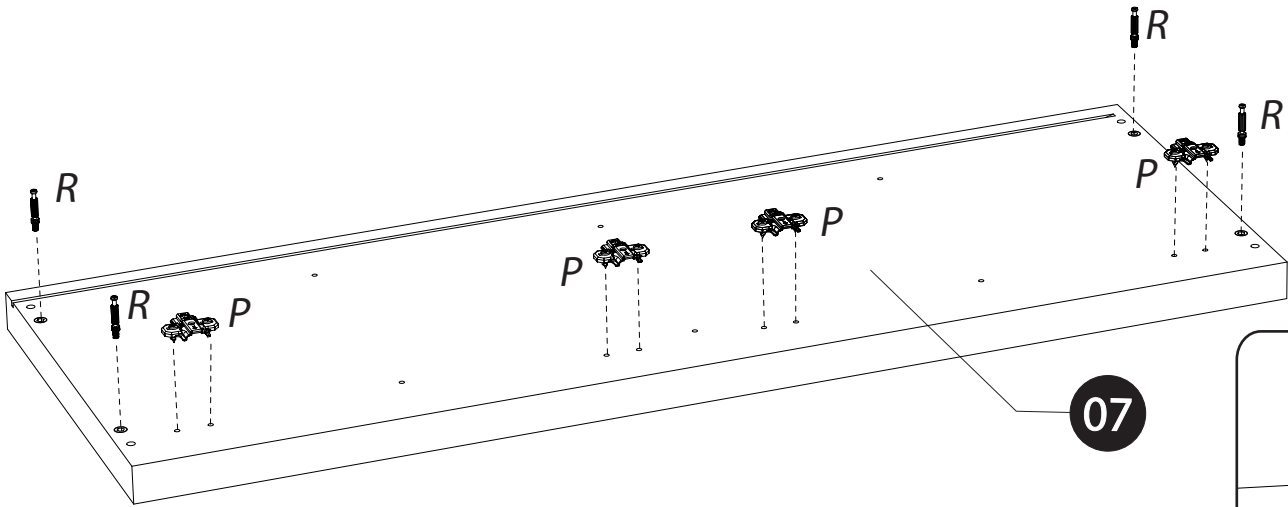
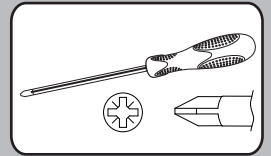
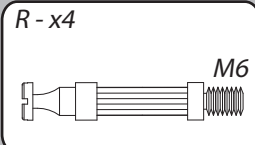
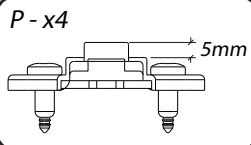

# 8

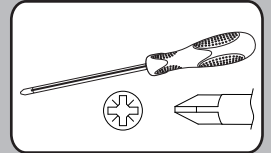

## 08

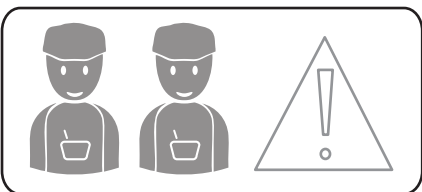
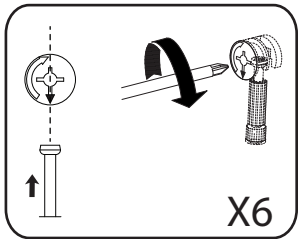
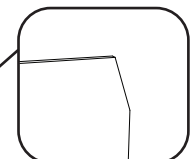
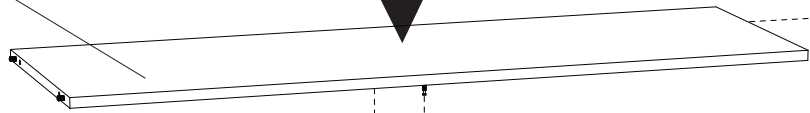

## 26

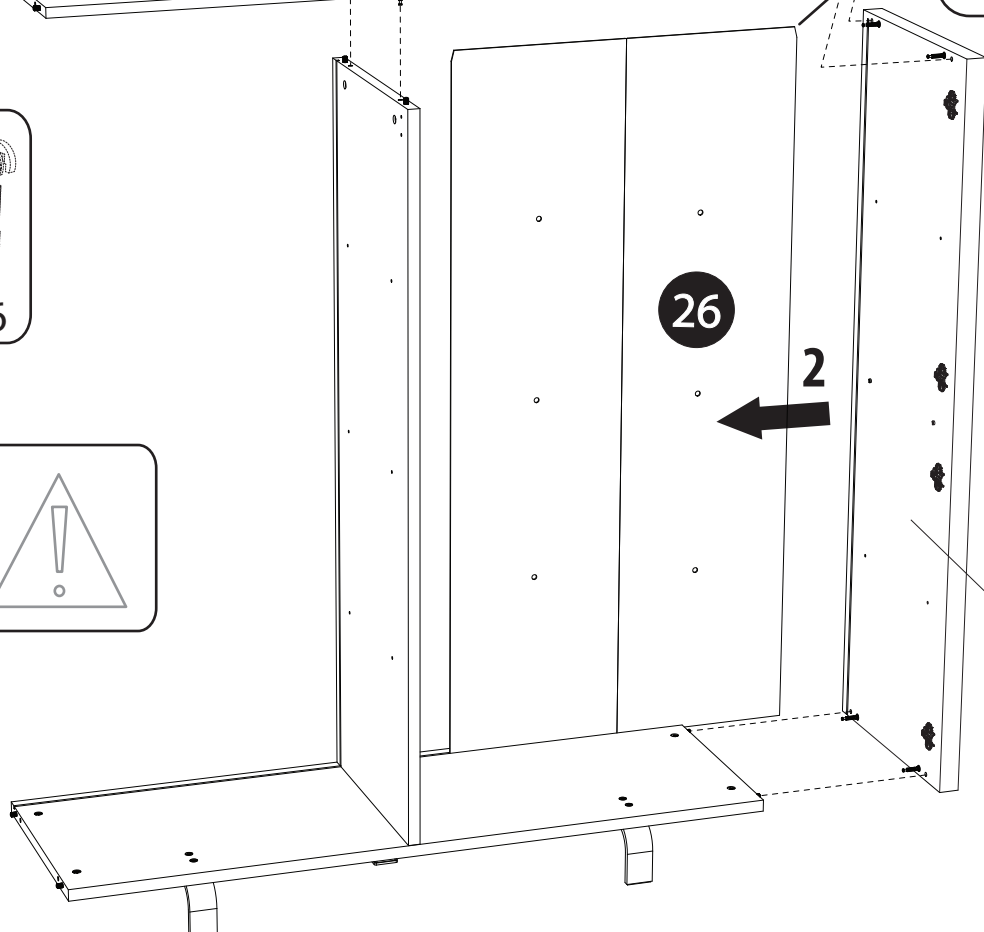

6

# 9

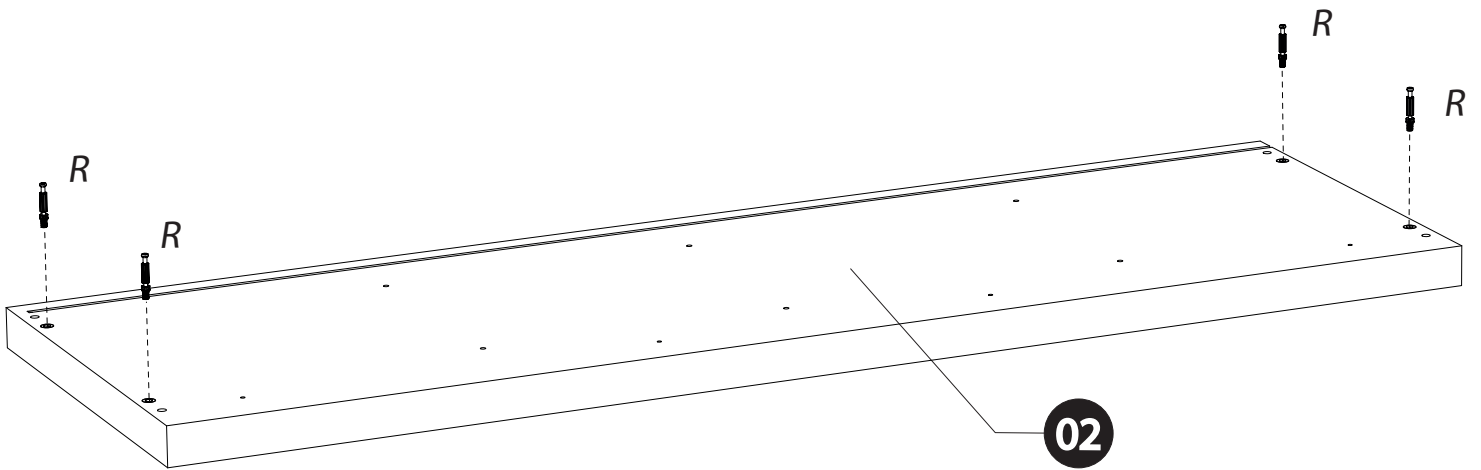
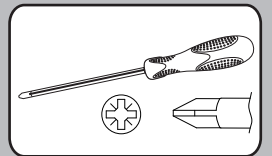
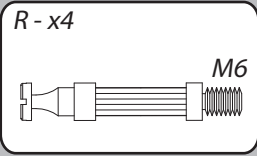

# 10

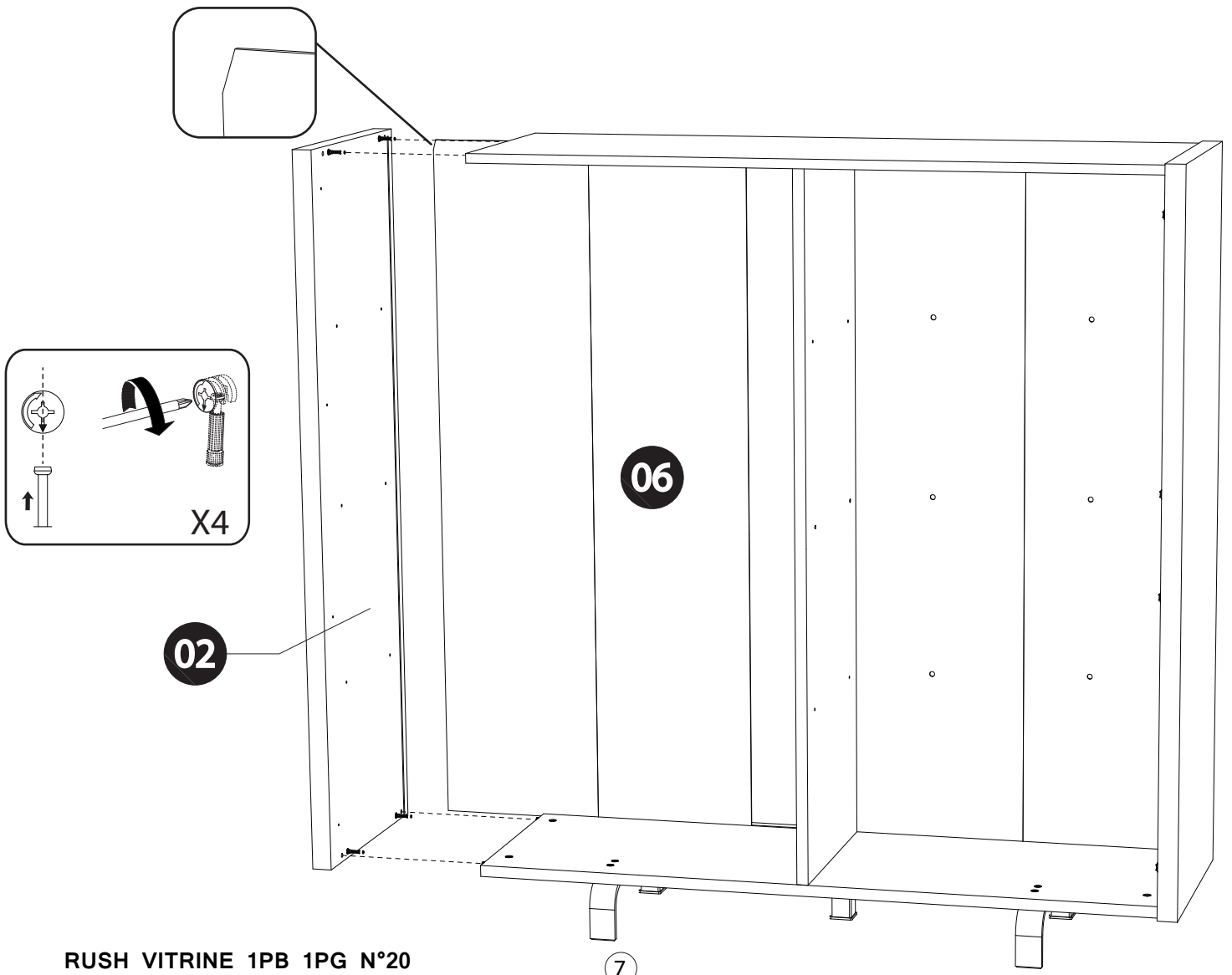
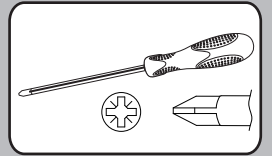

# 11

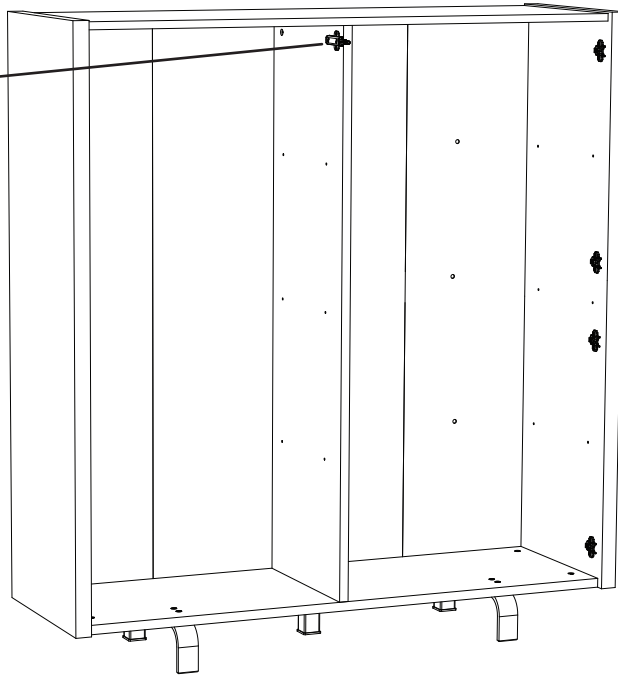
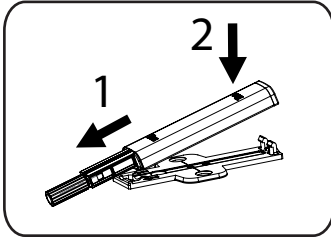
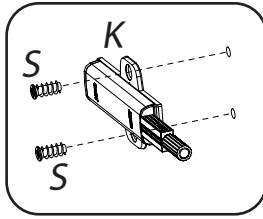
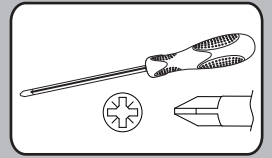
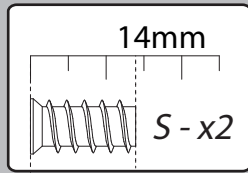
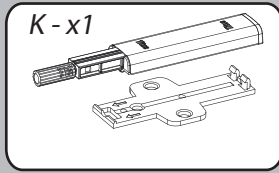

# 12

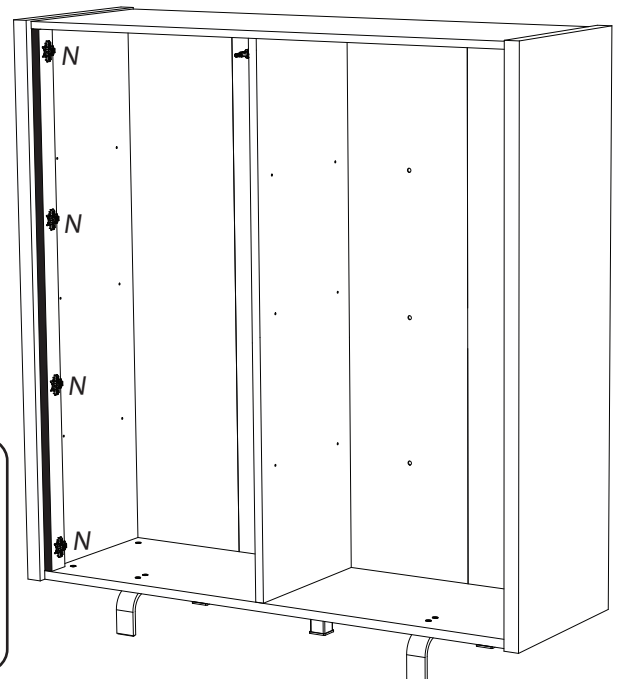
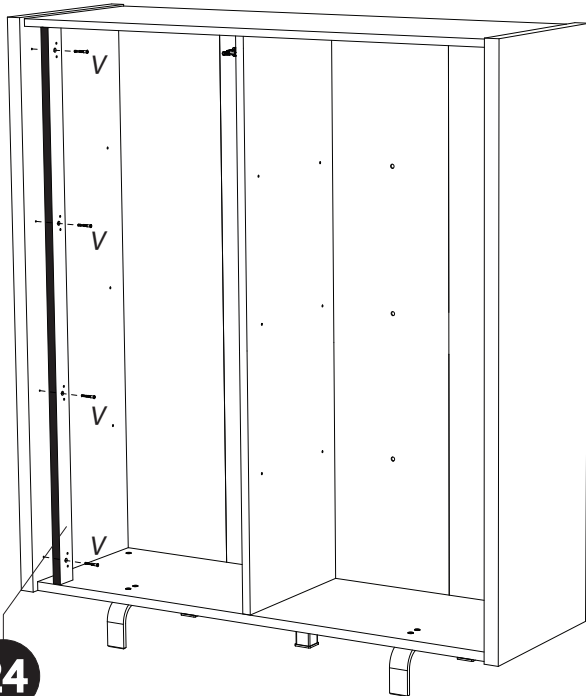
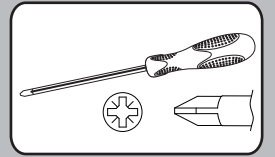
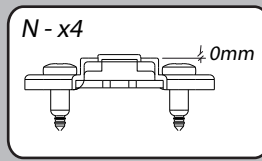
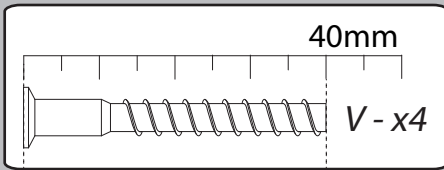

24

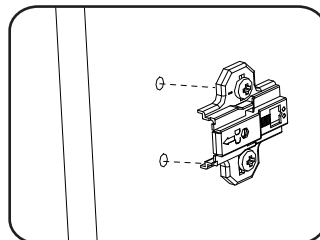



# 13

D - x12

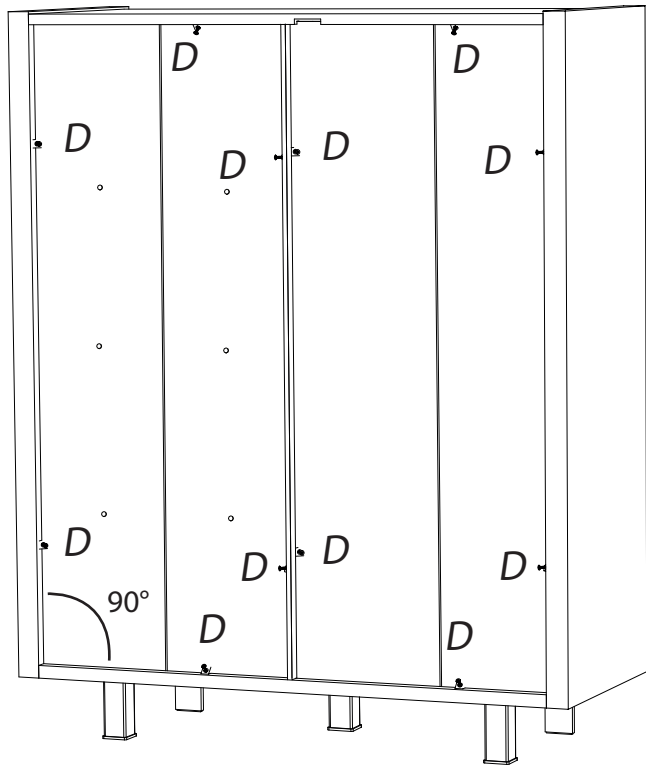
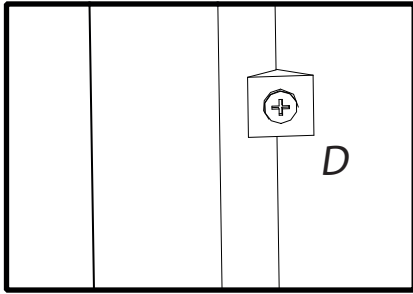
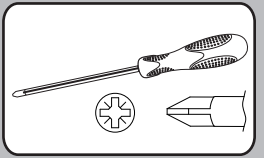
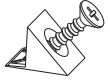

# 14

E - x12



D1 - x12

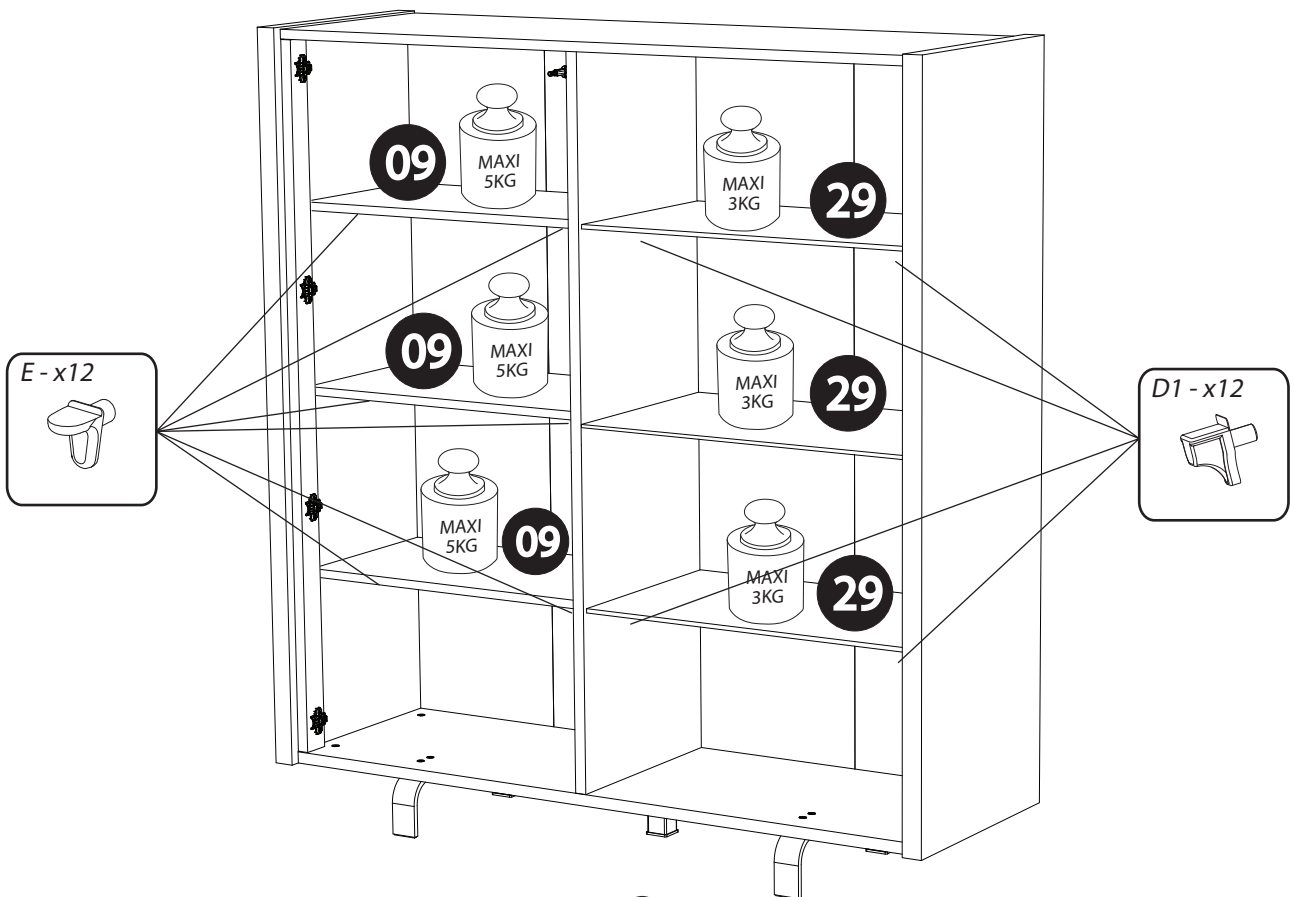



F

## INSTRUCTION GÉNÉRALE DU LUMINAIRE

### REMARQUES

SCIAE Dienville n'est pas responsable des dommages résultant :

- d'un mauvais montage
- de l'emploi d'outils inappropriés
- de changements techniques de l'ensemble
- du non-respect de cette instruction.

### A LIRE AVANT DE PROCEDER AU MONTAGE

L'ensemble est conçu pour une tension d'alimentation de 230V ~ 50Hz, il est fait en 2e classe de protection et marqué par un symbole  approprié.

L'indice de protection de l'ensemble : IP20

Brancher l'ensemble à une prise de 230V ~ 50Hz en bon état de fonctionnement.

Le montage doit être effectué conformément à l'instruction.

### ATTENTION !

Lors du montage, il faut strictement débrancher l'ensemble du courant 230V ~ 50Hz, respecter les règles de sécurité et rester particulièrement prudent.

La puissance électrique totale des montures de l'ensemble ne peut pas dépasser la puissance nominale du chargeur.

Les montures désignées par le symbole  doivent être installées sur une surface incombustible. Pour nettoyer, il faut utiliser uniquement un chiffon sec et ne jamais utiliser de produits chimiques.

### MONTAGE

Effectuer le montage dans l'ordre conforme au mode d'emploi.

Il faut s'assurer que toutes les connexions électriques et les fixations soit effectuées correctement, de façon à exclure tout fonctionnement défectueux.

Lors du déplacement des meubles, veillez particulièrement à ne pas endommager l'isolation des câbles électriques de l'ensemble.

EN

## GENERAL LUMINAIRE INSTRUCTION

### NOTES

SCIAE Dienville is not liable for any damage resulting from :

- a bad assembly
- the use of inappropriate tools
- of technical changes to the whole
- for non-compliance with this instruction.

### TO BE READ BEFORE ASSEMBLY

The unit is designed for a supply voltage of 230V ~ 50Hz, it is made in 2nd protection class and marked with an appropriate symbol .

The protection index of the set : IP20

Connect the unit to a 230V ~ 50Hz socket in good working order.

Installation must be carried out in accordance with the instructions.

### ATTENTION !

During installation, the entire 230V ~ 50Hz power supply must be strictly disconnected, respect the safety rules and remain particularly careful.

The total electrical power of the frames in the set may not exceed the charger's power rating.

Frames marked with the symbol  must be installed on a non-combustible surface.











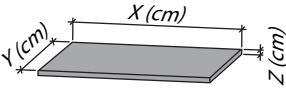
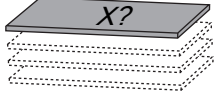
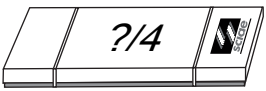

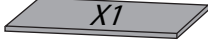
To clean, use only a dry cloth and never use chemicals.

### ASSEMBLY

Carry out the assembly in the order described in the operating instructions.

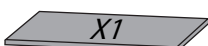
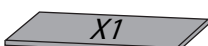
Make sure that all electrical connections and fixings are carried out correctly, so that faulty operation is excluded.

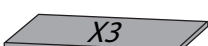
When moving the furniture, be particularly careful not to damage the following when moving it the insulation of the electric cables of the whole.

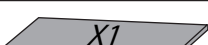
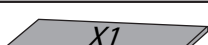
<i>DESIGNATION</i>		N°		
Dessous	132.4 x 43.5 x 2.2	1		2
Côté gauche	140.5 x 45.5 x 3.8	2		3
Séparation	136.1 x 43.4 x 2.2	3		2
Derrière gauche pliant	137 x 64 x 0.25	6		3
Côté droit	140.5 x 45.5 x 3.8	7		3
Dessus	132.4 x 43.5 x 1.8	8		2
Tablettes gauche	63 x 35 x 1.6	9		1
Recharge de porte gauche	135.3 x 42.5 x 1.2	10		2
Montant de porte droite	140.5 x 19.7 x 1.6	11		4
Recharge d'embase	136 x 5.5 x 2.2	24		2
Derrière droit pliant	137 x 68 x 0.25	26		3
Habillage gauche porte gauche	140.5 x 10.7 x 1.6	27		4
Tablette verre	66.9 x 40 x 0.5	29		1
Habillage centrale porte gauche	140.5 x 19.7 x 1.6	30		4
Habillage droit porte gauche	140.5 x 26.8 x 1.6	31		4
Glace de porte droite	135.3 x 51 x 0.5	34		4

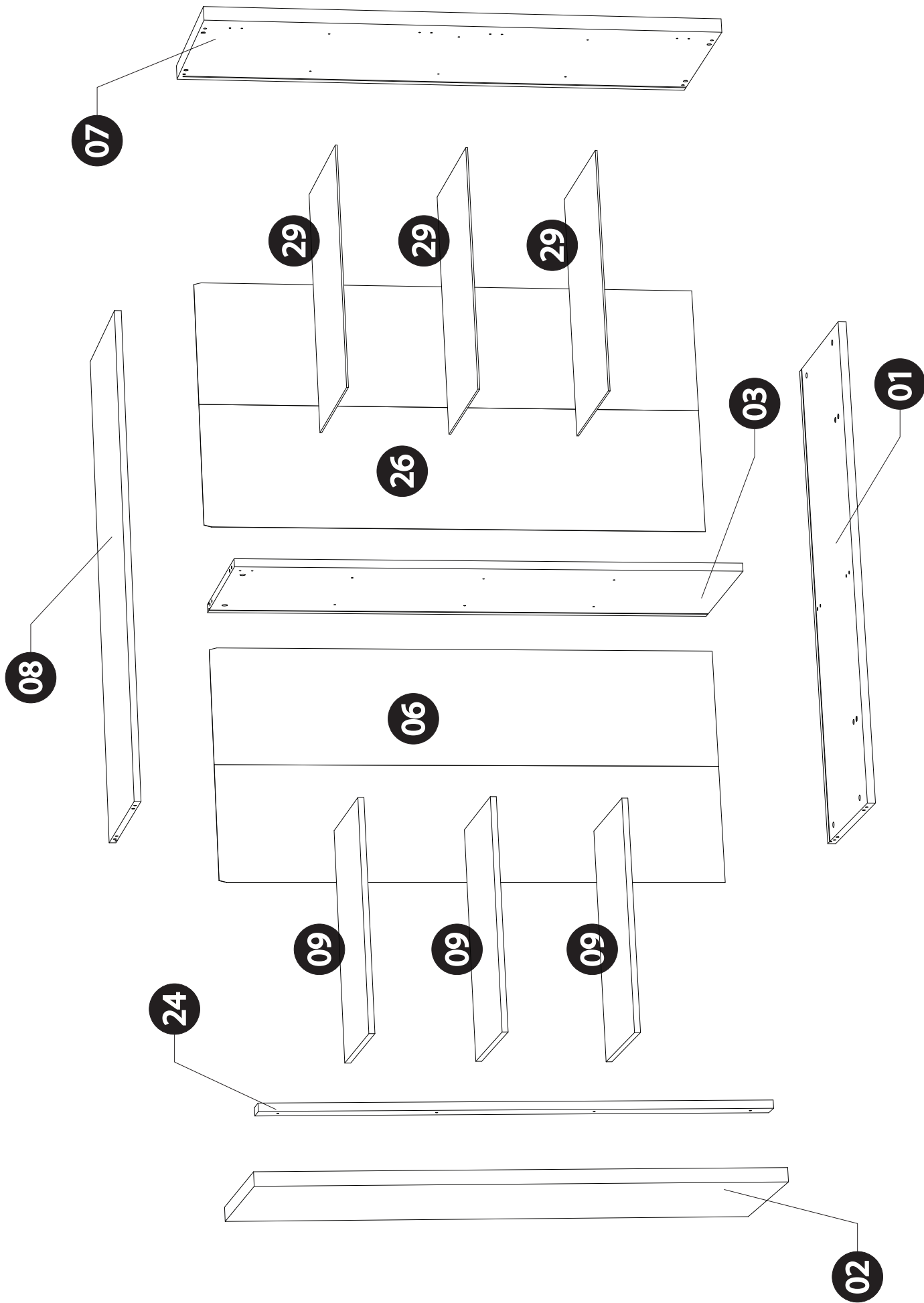

11

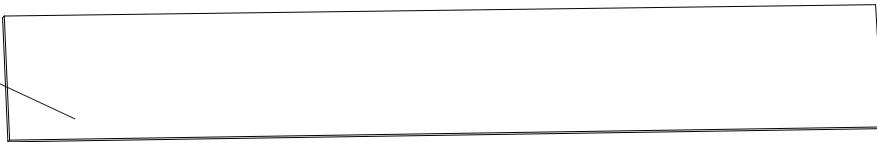

34

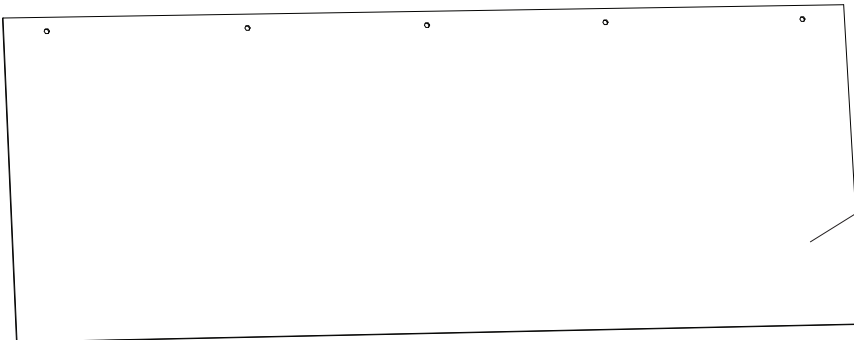

10

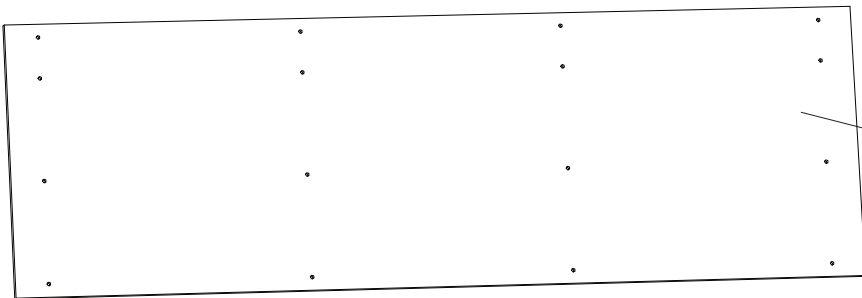

31



27



30

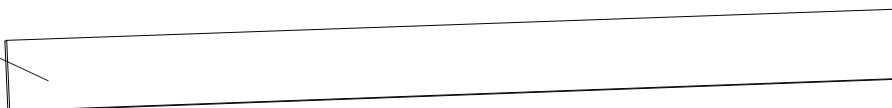

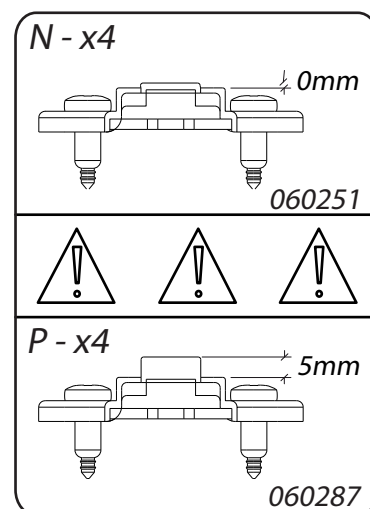
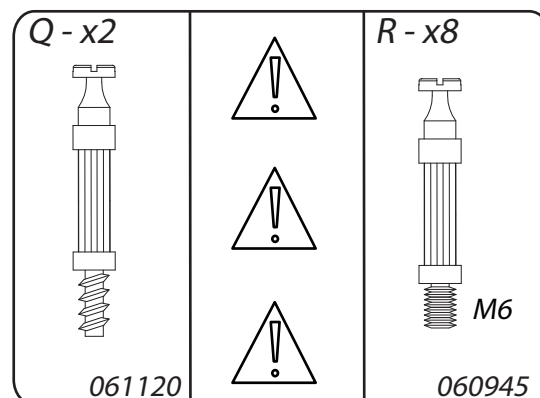
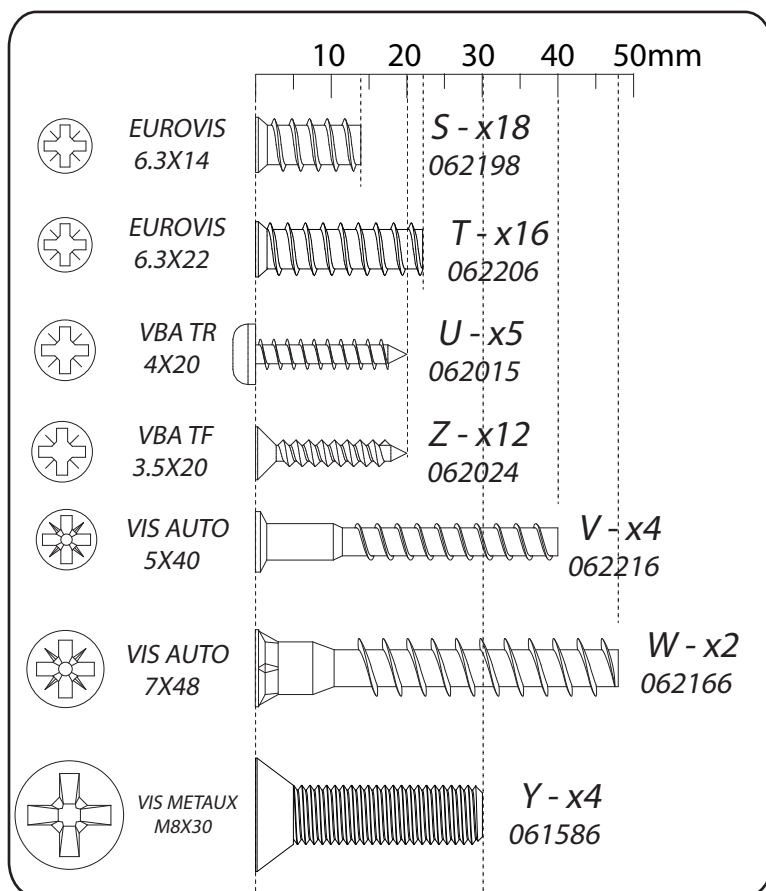
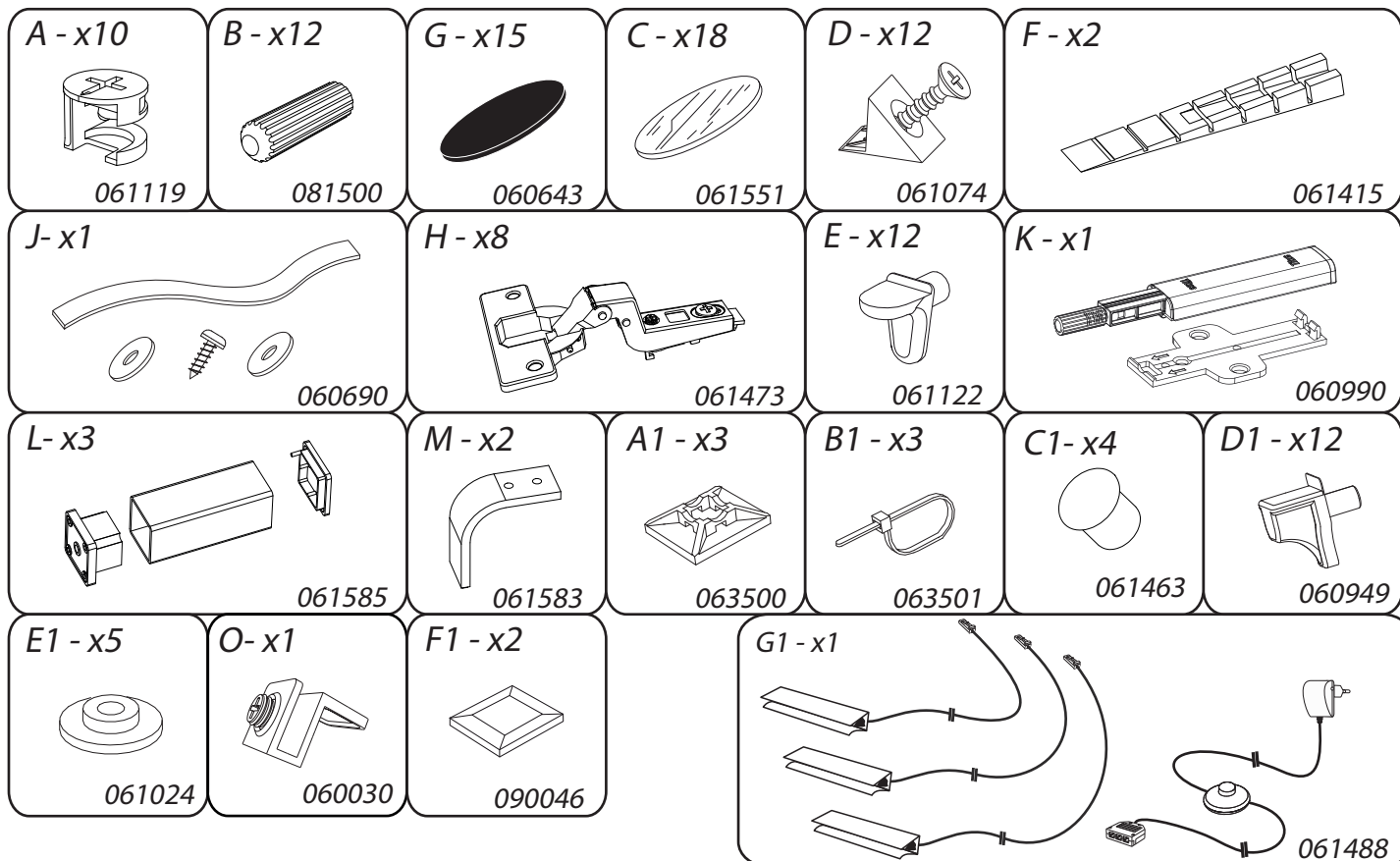

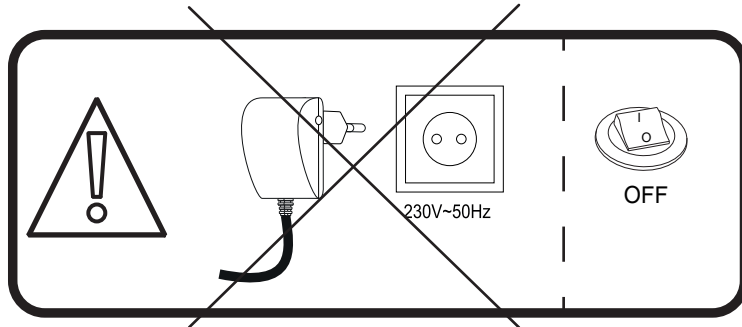
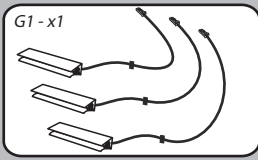

**FRANCAIS**

"Ce luminaire est un produit de décoration. Ce luminaire ne convient pas pour l'illumination d'une pièce d'un ménage."

**ENGLISH**

"This lighting is a decoration product. This lighting is not suitable for the illumination of a household's room."

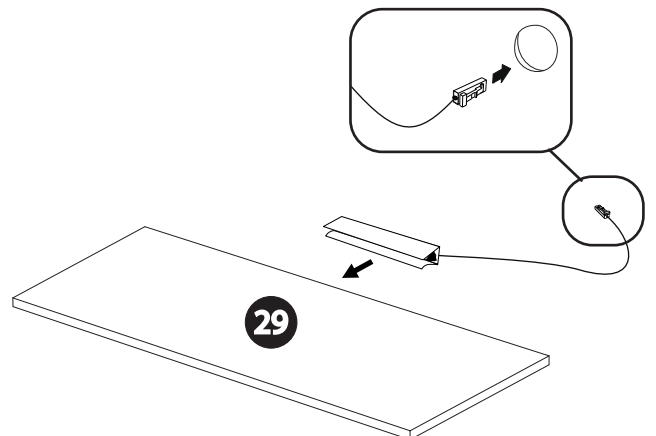
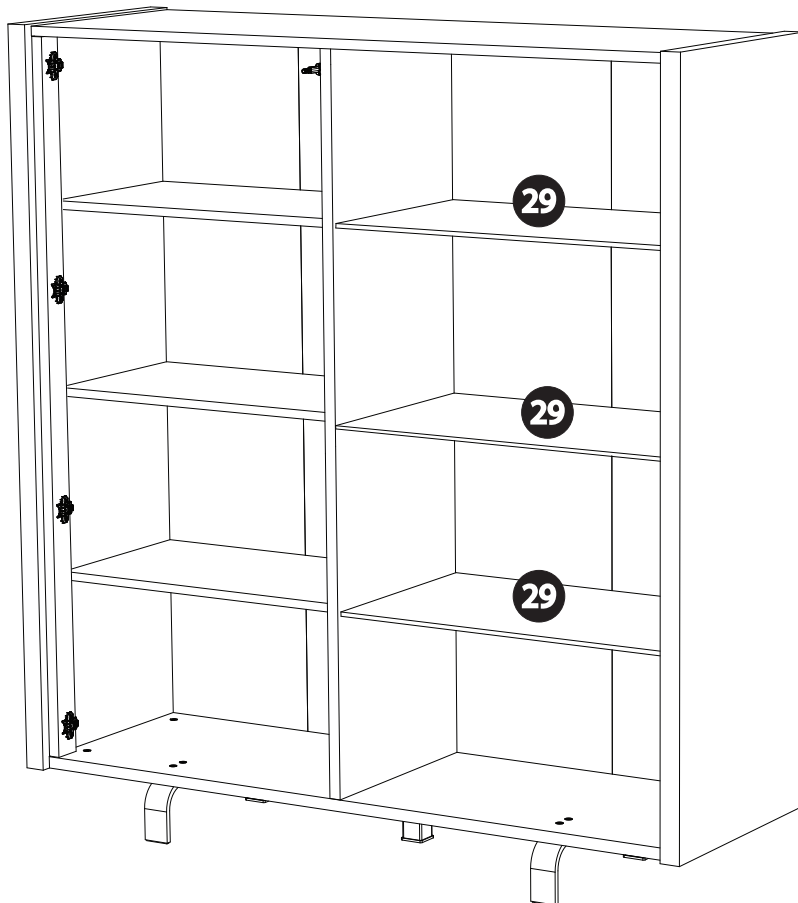
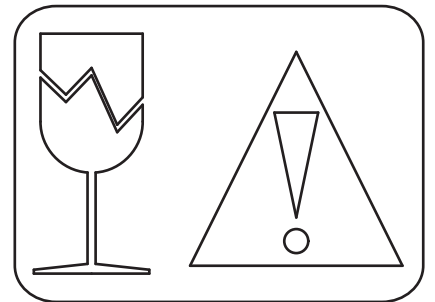

A1 - x3



B1 - x3



G1 - x1

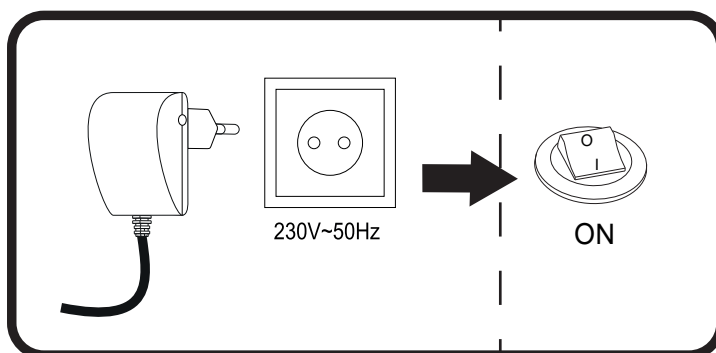
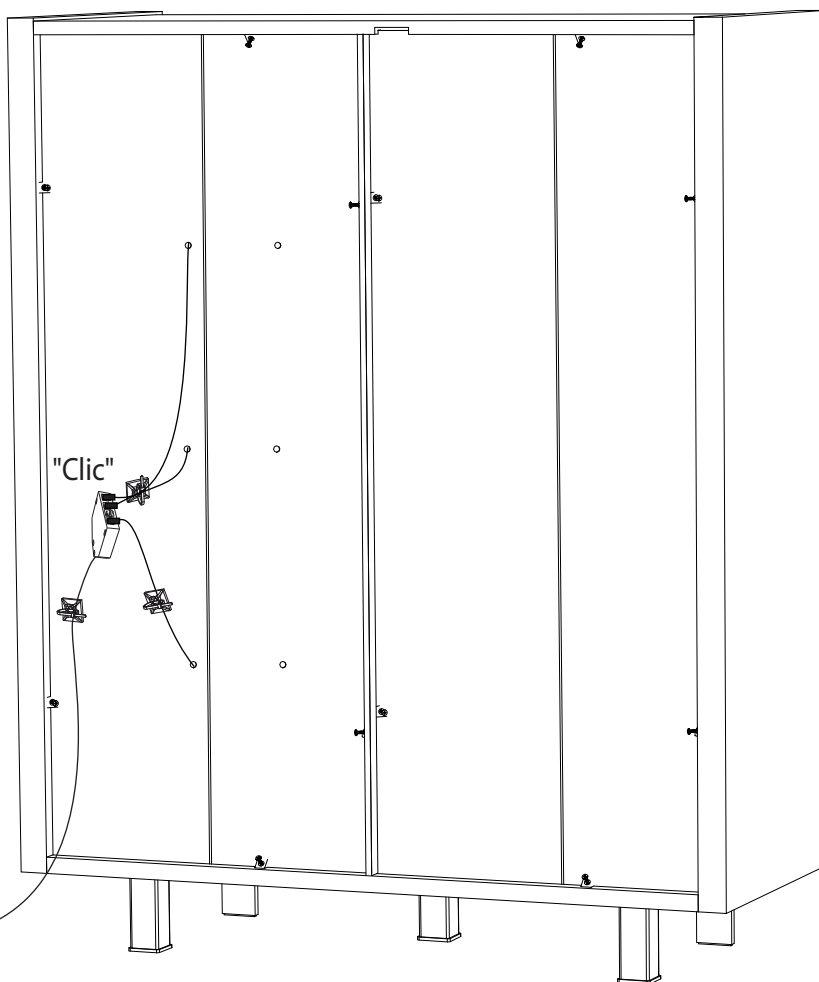
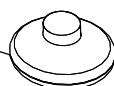
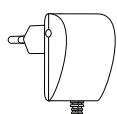
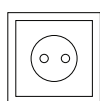
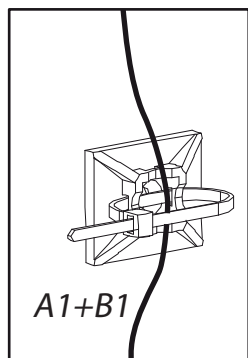
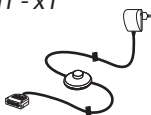



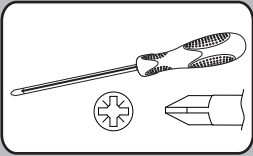
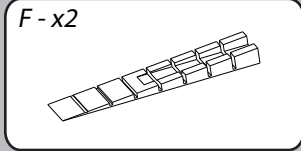
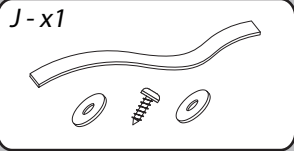

FRANCAIS: Pour votre sécurité il est impératif de fixer votre meuble au mur.  
 ENGLISH: For your own safety, this furniture must be fastened to the wall imperatively.  
 DEUTSCH: Zu Ihre Sicherheit, ist es notwendig Ihr Möbel auf dem Wand zu fixieren.

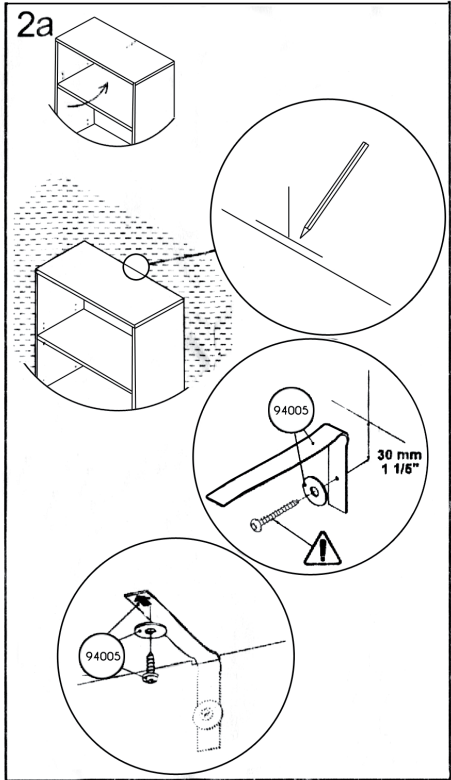
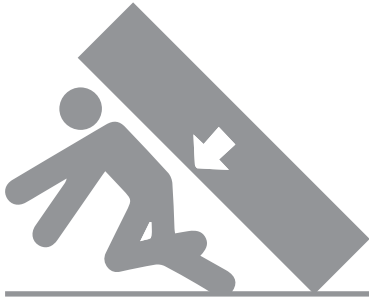

FRANCAIS  
**IMPORTANT:** La vis fournie avec le dispositif anti-bascule est destinée à fixer le dispositif dans le meuble. Pour la fixation au mur, compléter par une vis adaptée au support mural. En cas de doute, contacter un magasin de bricolage.

ENGLISH  
**IMPORTANT:** The screw supplied together with the anti-topple bracket is to be used only for fixing the anti-topple bracket to the furniture. In addition to this, you will need to choose a screw or fitting which is suitable for securing the bracket to the kind of walls you have. If you are unsure about what type of screw to use contact your local hardware store.

DEUTSCH  
**WICHTIG:** Die dem kippschutz beigefügten schrauben sind ausschließlich für die befestigung des kippschutzes am möbelstück vorgesehen. Für die befestigung des kippschutzes an der wand benötigen sie zusätzlich schrauben oder beschläge, die zur beschaffenheit der wand passen. Falls sie nicht sicher sind, welche art von schrauben geeignet sind, wenden sie sich bitte an den fachhandel.

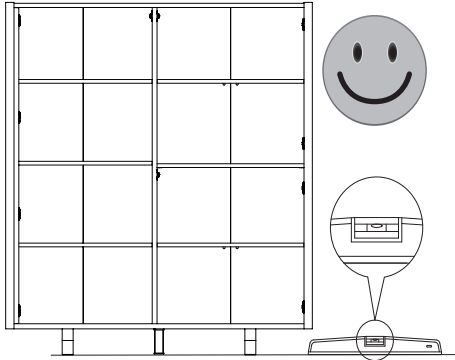
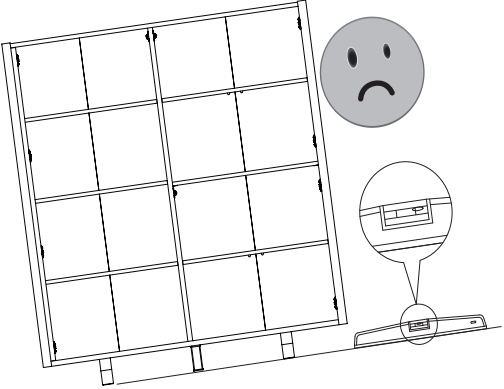
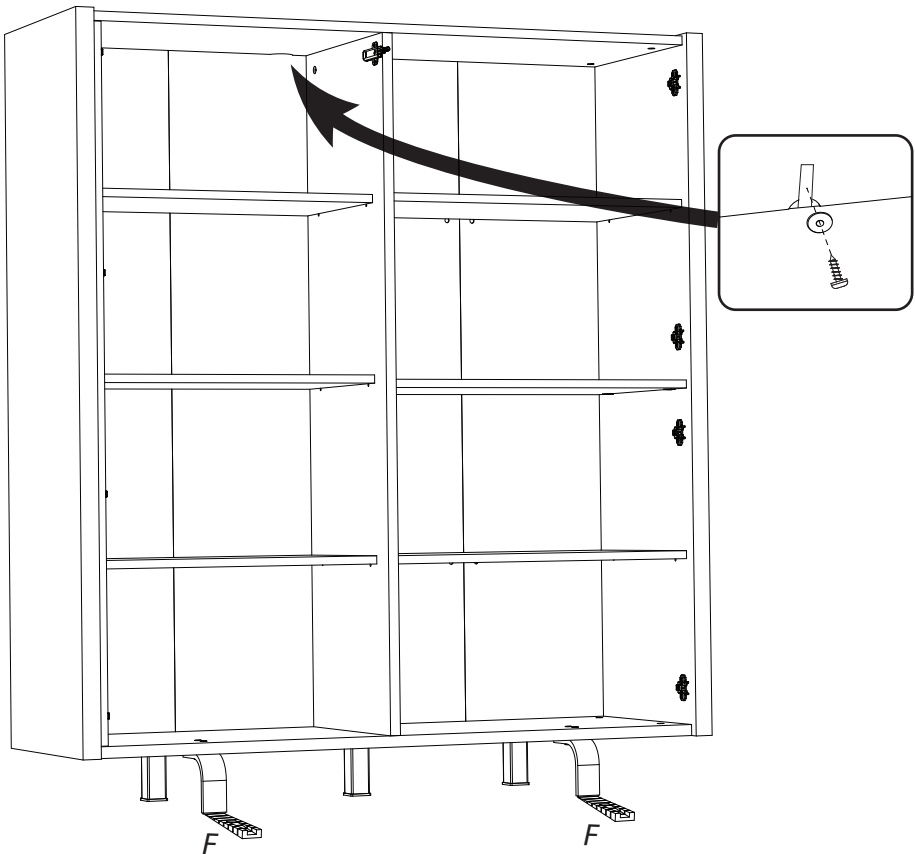

# 18

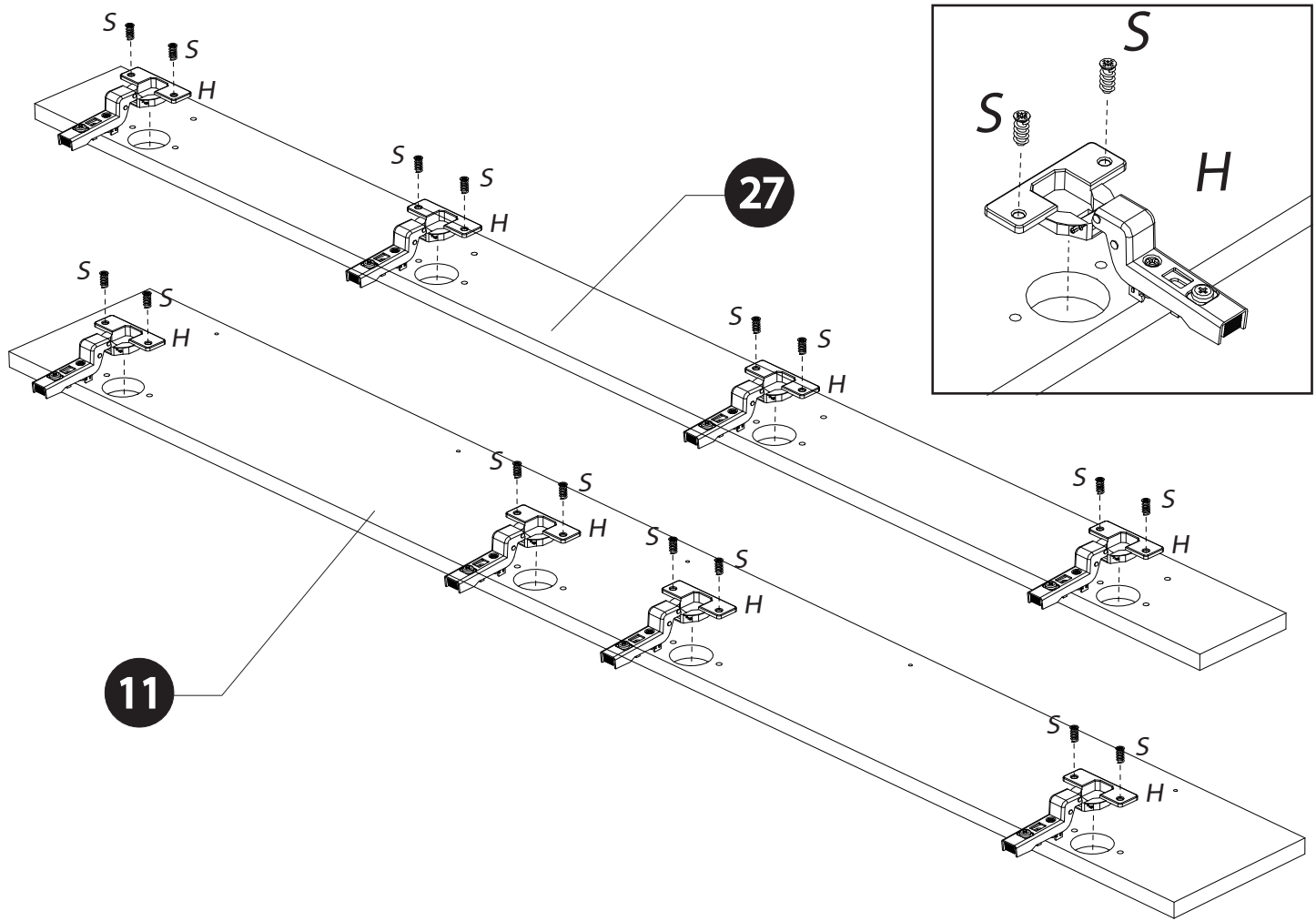
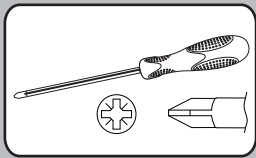
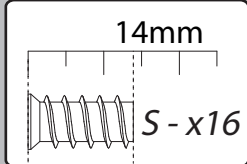
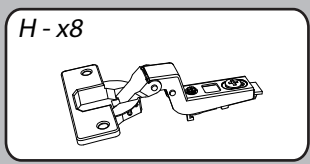

# 19

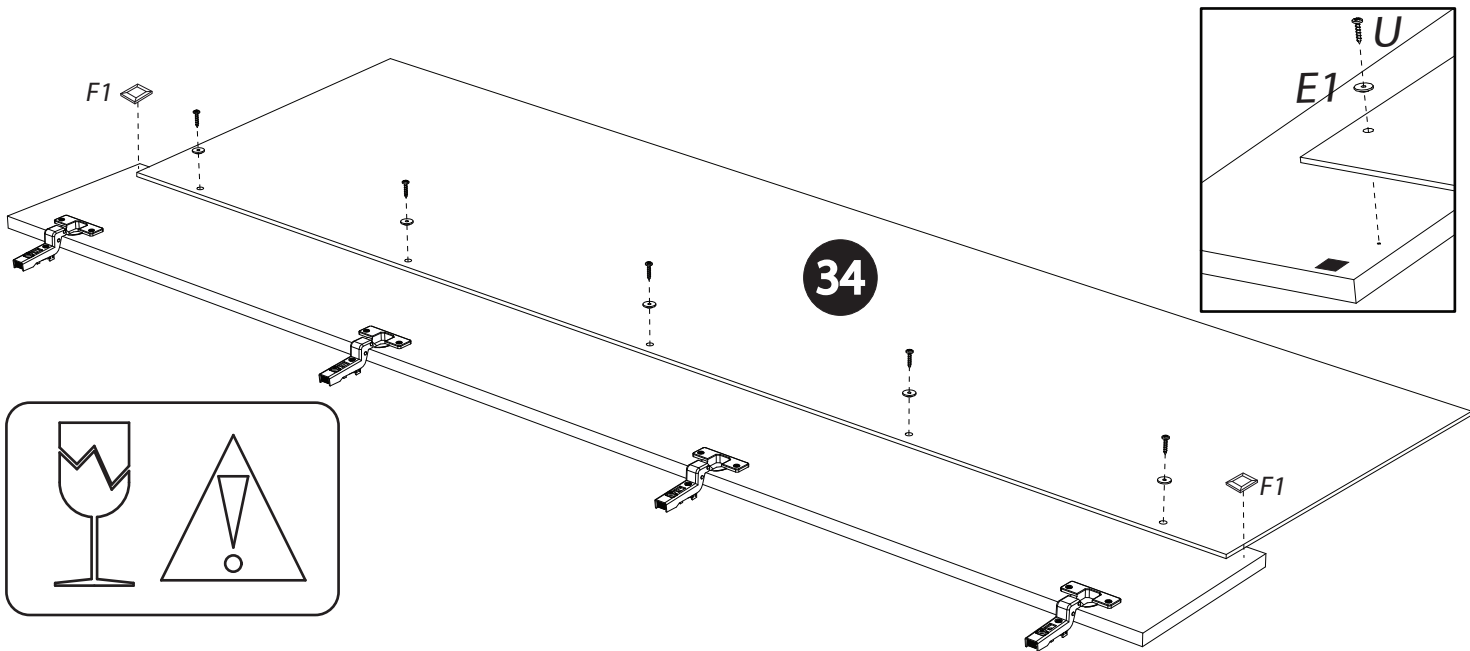
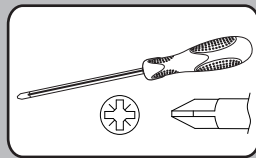
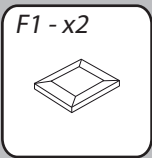
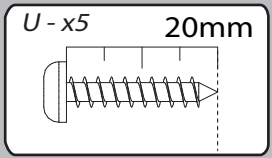
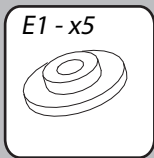

# 20

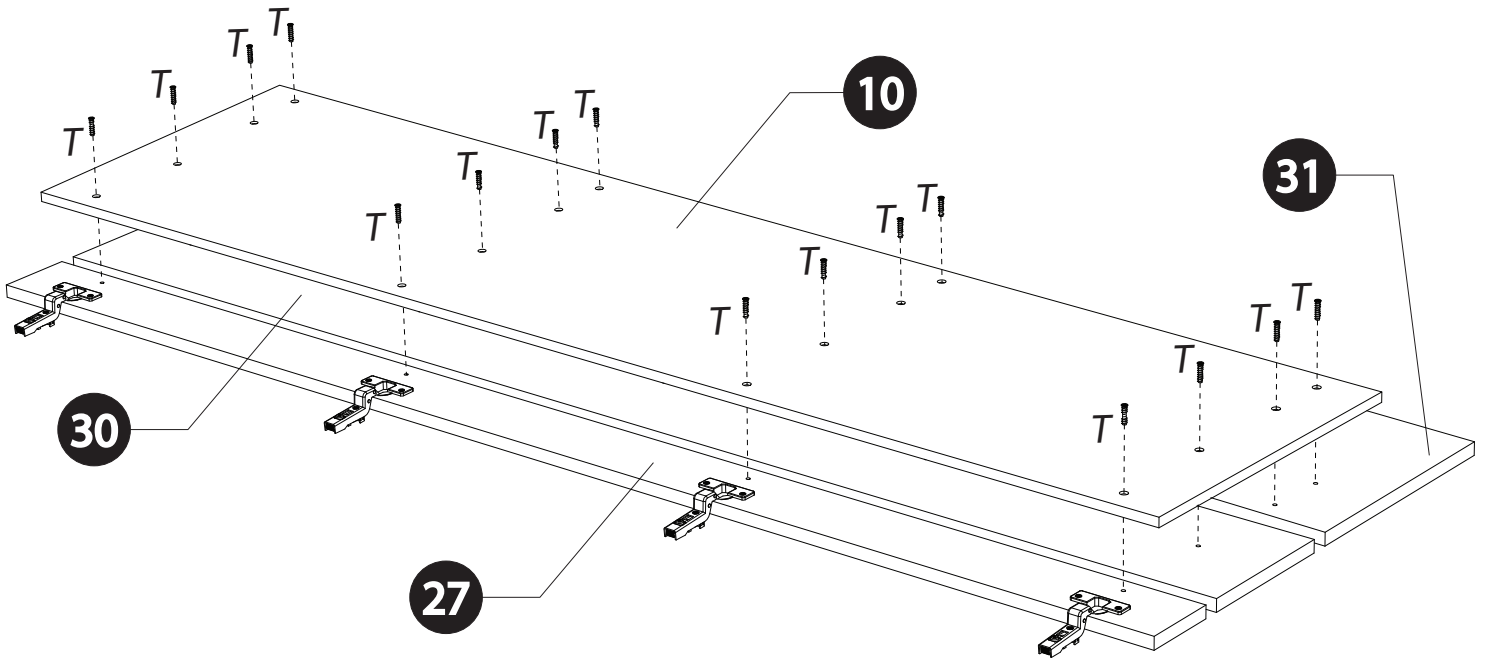
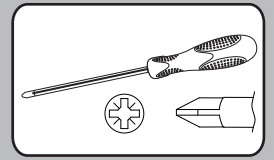
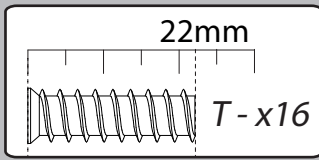

# 21

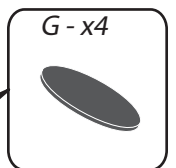
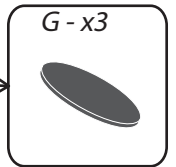
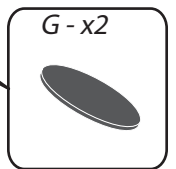
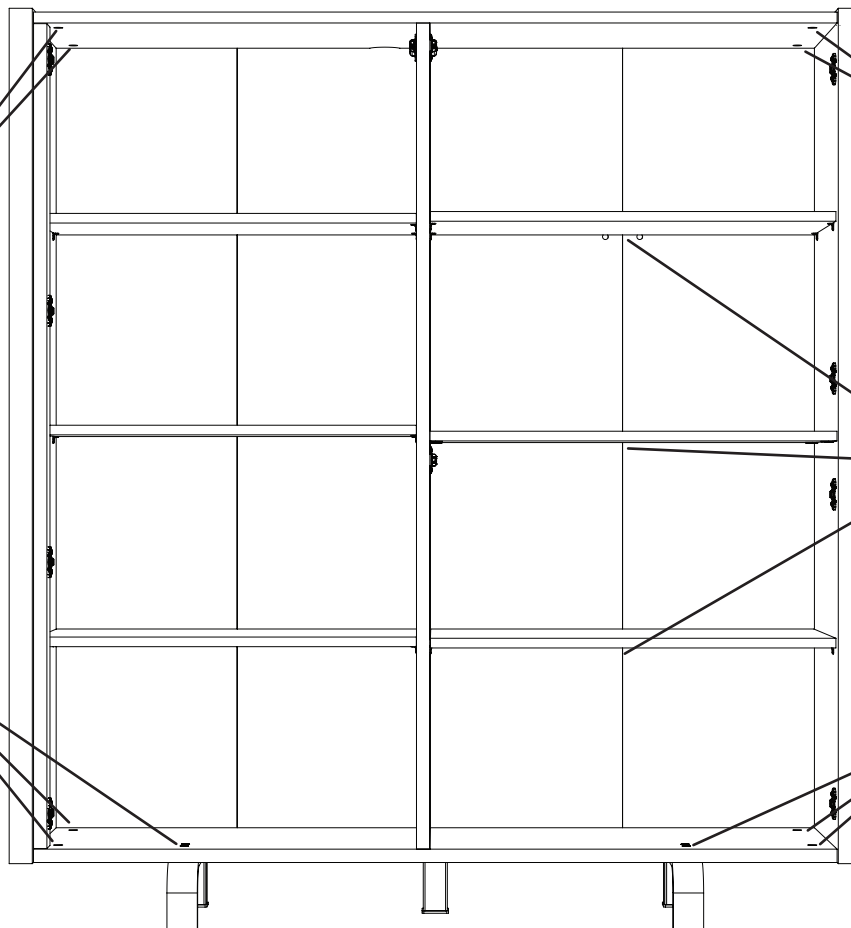
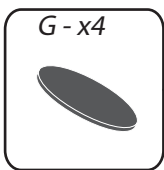
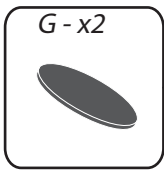
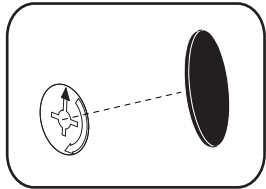

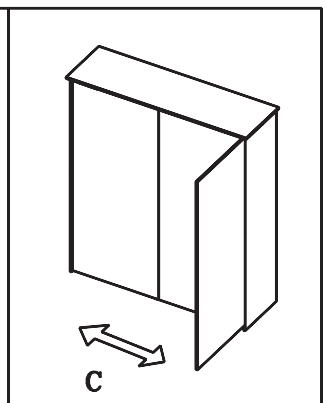
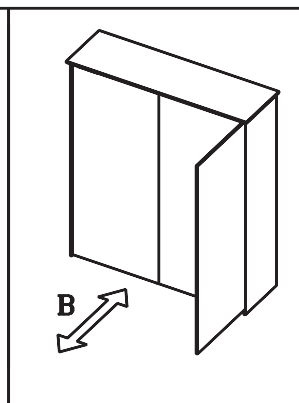
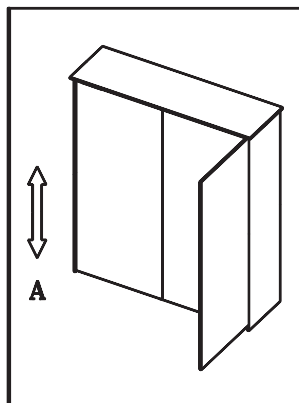
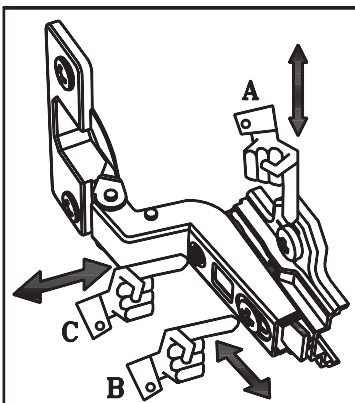
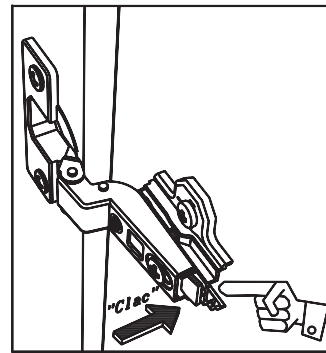
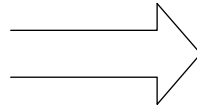
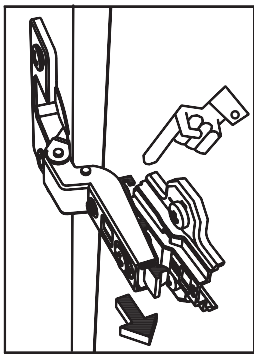
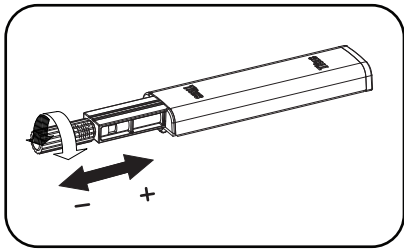
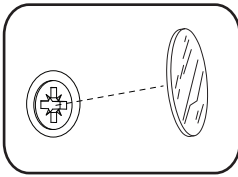
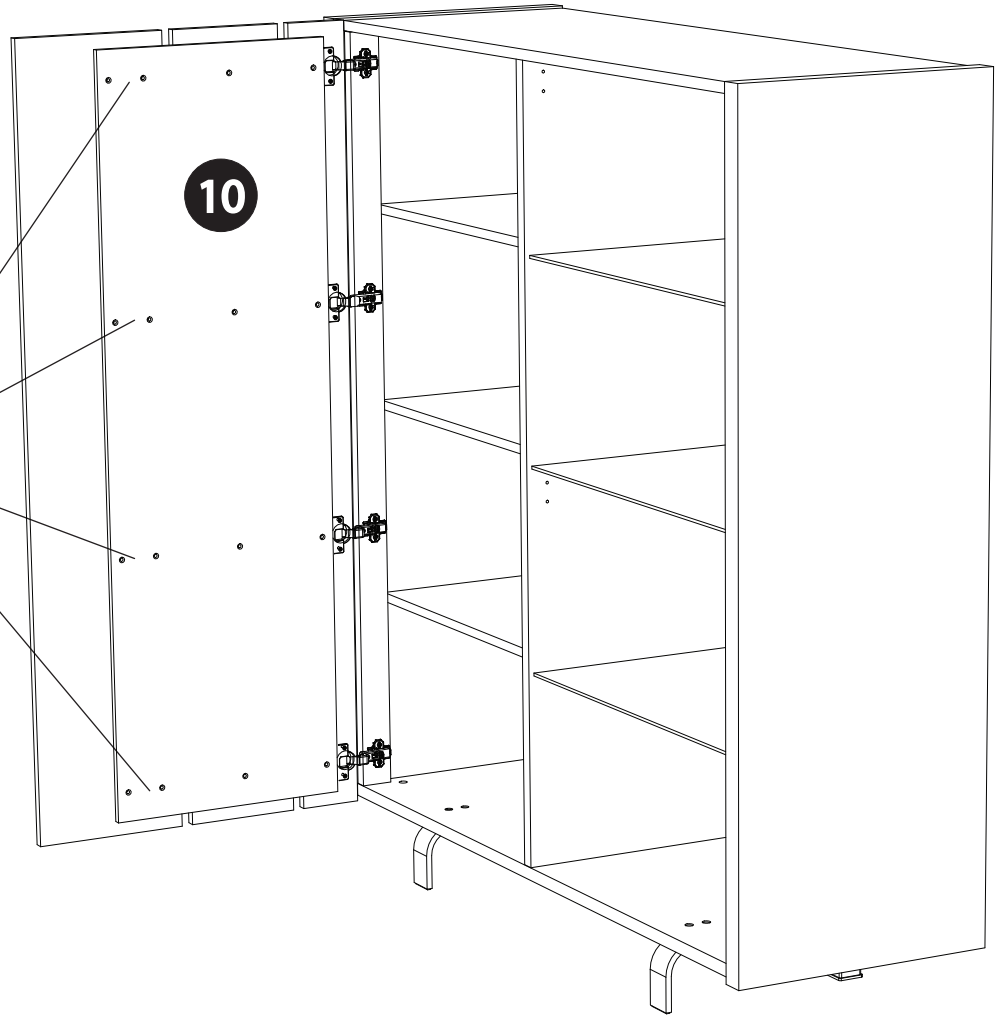
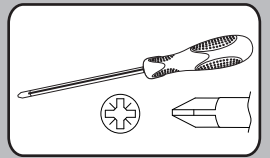

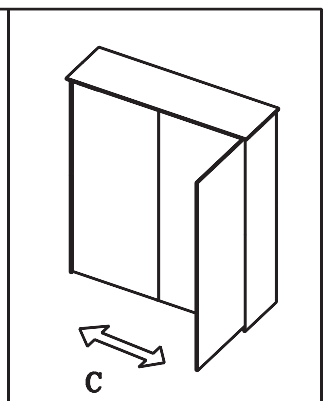
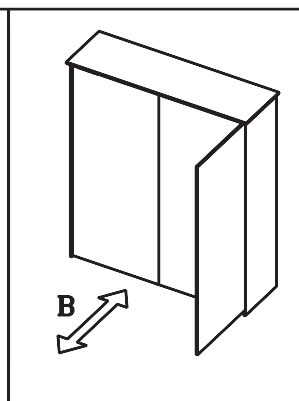
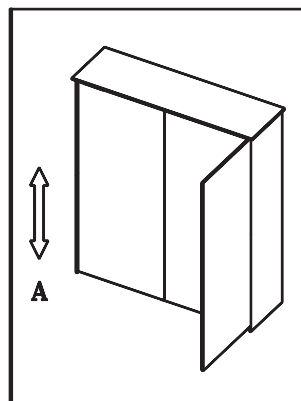
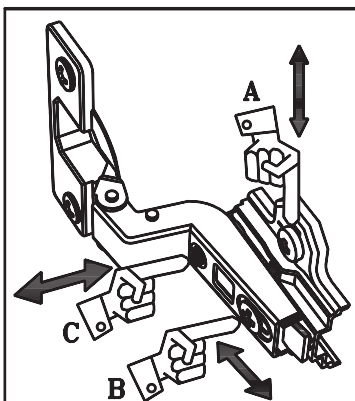
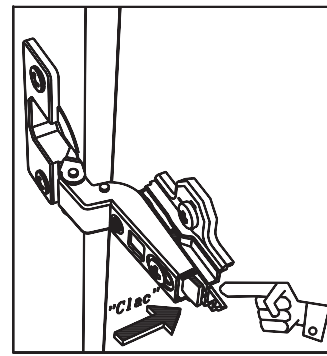
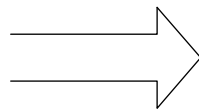
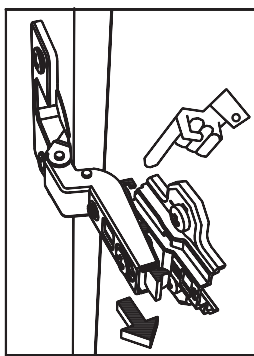
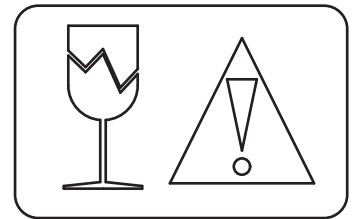
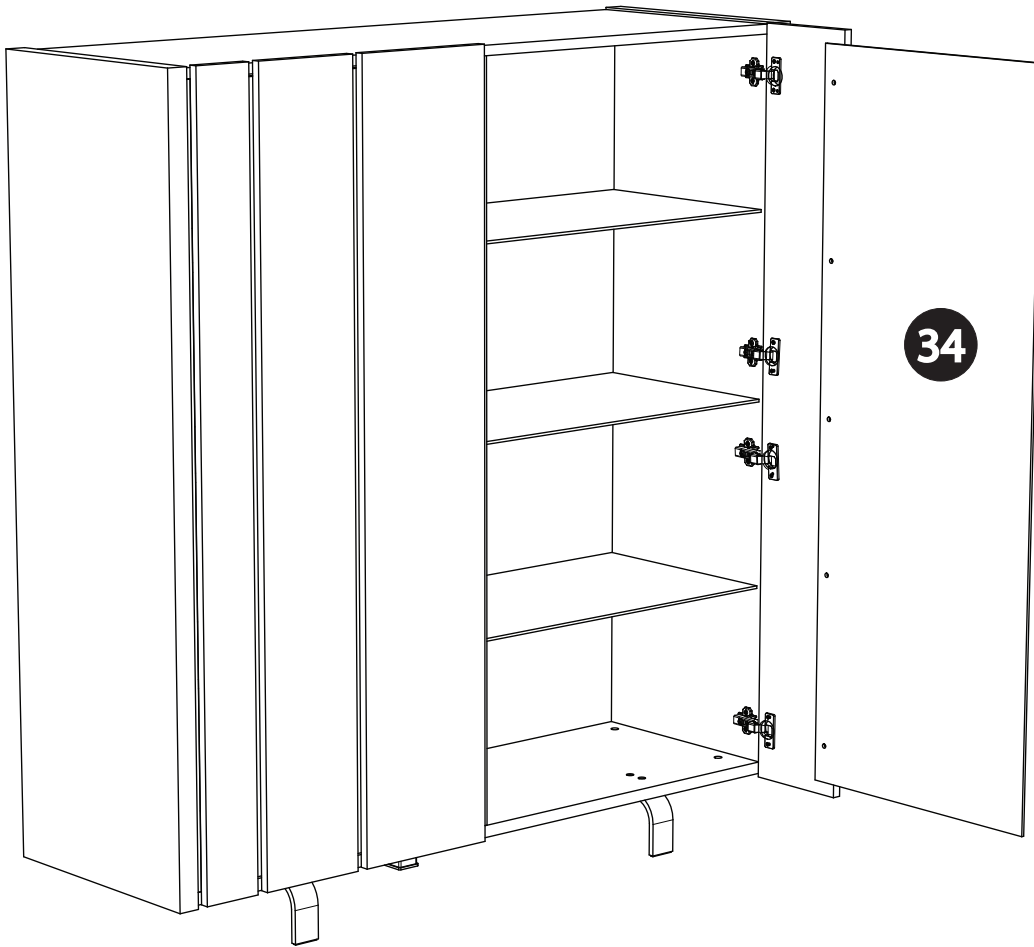
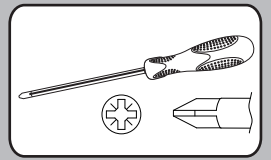





## RUSH 4405:

Vitrine 1pb 1pg composé de panneaux de particules revêtus papier décor chêne et papier noir uni.

Panneaux de particules mélaminés décor ardoise noir métallisé pour le dessus.

L.140 cm - H.151,5 cm - P.45,5 cm.

A monter soi-même.

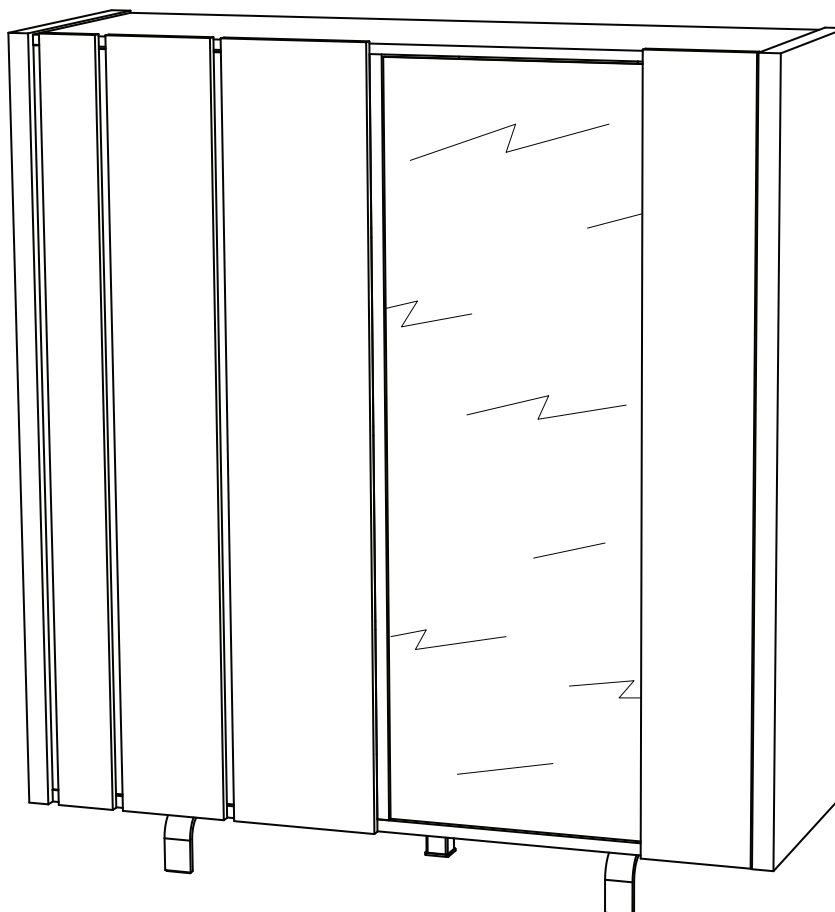

### FRANCAIS

#### Recommandations de démontage :

En cas de déménagement, il convient de procéder au démontage de votre meuble, en ôtant toute la visserie.

### ENGLISH

#### Disassembly advices:

In case of moving, it is needed to dismantle the furniture removing the fittings.

### DEUTSCH

#### Empfehlungen für die Demontage:

Bei Transport bitte alle Beschläge demontieren.

"Les meubles contenant des panneaux à base de bois (panneaux de particules, panneaux de fibres, contreplaqué...) peuvent émettre des substances polluantes dans l'air intérieur. Il est ainsi recommandé, après l'installation du meuble dans son logement, d'aérer fréquemment la pièce concernée pendant au moins quatre semaines afin de réduire son exposition aux polluants émis par le meuble."