

Luxor 3 & 4.



900794



Emissionsgeprüft
Schadstoffgeprüft
Regelmäßige
Produkt-
überwachung

www.tuv.com
ID 1111253053



- Alle afmetingen zijn ca afmetingen onder voorbehoud van vergissingen en technische wijzigingen.

Luxor 3 & 4.



LEVERBARE ROMP- EN FRONUITVOERINGEN

Graag bij iedere bestelling de juiste kleurcombinatie van front en romp aangeven!

Prijsgroep 1: front glad, met ronde rand

Prijsgroep 2: front met lijsten

Kleuruitvoeringen:



Kleuruitvoeringen:



Grepen chroom



Grepen chroom

Modelnr. 724
Ruw-eiken-decor

Modelnr. 725
Ruw-eiken-decor

Modelnr. 726
Decor imitatie Lariks

Modelnr. 727
Decor imitatie Lariks

Modelnr. 717
Imitatie steeneiken

Modelnr. 718
Imitatie steeneiken

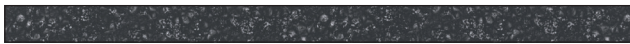

Grepen in rawsteel

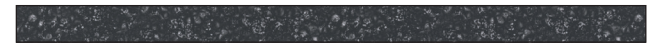

Grepen in rawsteel

Modelnr. 739
Ruw-eiken-decor

Modelnr. 743
Ruw-eiken-decor

Modelnr. 740
Decor imitatie Lariks

Modelnr. 744
Decor imitatie Lariks

Modelnr. 728
Imitatie steeneiken

Modelnr. 729
Imitatie steeneiken

furnplan



Emissionsgeprüft
Schadstoffgeprüft
Regelmäßige
Produkt-
überwachung

www.tuv.com
ID 1111253053



Luxor 3 & 4.



900794



Emissionsgeprüft
Schadstoffgeprüft
Regelmäßige
Produkt-
überwachung

www.tuv.com
ID 1111253053



• Alle afmetingen zijn ca afmetingen onder voorbehoud van vergissingen en technische wijzigingen.

Luxor 3 & 4.



900794



Emissionsgeprüft
Schadstoffgeprüft
Regelmäßige
Produkt-
überwachung

www.tuv.com
ID 1111253053



Luxor 3 & 4.



900794



Emissionsgeprüft
Schadstoffgeprüft
Regelmäßige
Produkt-
überwachung

www.tuv.com
ID 1111253053



- Alle afmetingen zijn ca afmetingen onder voorbehoud van vergissingen en technische wijzigingen.

Luxor 3 & 4.



900794



Emissionsgeprüft
Schadstoffgeprüft
Regelmäßige
Produkt-
überwachung

www.tuv.com
ID 1111253053



Luxor 3 & 4.



900794



Emissionsgeprüft
Schadstoffgeprüft
Regelmäßige
Produkt-
überwachung
www.tuv.com
ID 1111253053



- Alle afmetingen zijn ca afmetingen onder voorbehoud van vergissingen en technische wijzigingen.

Luxor 3 & 4.



900794



Emissionsgeprüft
Schadstoffgeprüft
Regelmäßige
Produkt-
überwachung

www.tuv.com
ID 1111253053



Luxor 3 & 4.



Rombreedten

B	Kast	Sokkel	Kast	Sokkel	Kast	Sokkel	Kast	Sokkel	Kast	Sokkel	Kast	B effectieve
33	1,5	30,2	1,5									33,2 cm
50	1,5	47,5	1,5									50,5 cm
75	1,5	72,3	1,5									75,3 cm
100	1,5	30,2	1,5	30,2	1,5	30,2	1,5					96,6 cm
100	1,5	96,4	1,5									99,4 cm
125	1,5	72,3	1,5	47,5	1,5							124,3 cm
133	1,5	47,5	1,5	30,2	1,5	47,5	1,5					131,2 cm
150	1,5	96,4	1,5	47,5	1,5							148,4 cm
150	1,5	47,5	1,5	47,5	1,5	47,5	1,5					148,5 cm
175	1,5	47,5	1,5	72,3	1,5	47,5	1,5					173,3 cm
200	1,5	96,4	1,5	96,4	1,5							197,3 cm
200	1,5	72,3	1,5	47,5	1,5	72,3	1,5					198,1 cm
225	1,5	72,3	1,5	72,3	1,5	72,3	1,5					222,9 cm
250	1,5	96,4	1,5	47,5	1,5	96,4	1,5					246,3 cm
275	1,5	96,4	1,5	72,3	1,5	96,4	1,5					271,1 cm
300	1,5	96,4	1,5	96,4	1,5	96,4	1,5					295,2 cm
300	1,5	72,3	1,5	47,5	1,5	47,5	1,5	47,5	1,5	72,3	1,5	296,1 cm
325	1,5	96,4	1,5	72,3	1,5	47,5	1,5	96,4	1,5			320,1 cm
325	1,5	47,5	1,5	72,3	1,5	72,3	1,5	72,3	1,5	47,5	1,5	320,9 cm
350	1,5	96,4	1,5	96,4	1,5	47,5	1,5	96,4	1,5			344,2 cm
350	1,5	96,4	1,5	47,5	1,5	47,5	1,5	47,5	1,5	96,4	1,5	344,3 cm
375	1,5	96,4	1,5	47,5	1,5	72,3	1,5	47,5	1,5	96,4	1,5	369,1 cm
400	1,5	96,4	1,5	96,4	1,5	96,4	1,5	96,4	1,5			393,1 cm
400	1,5	96,4	1,5	72,3	1,5	47,5	1,5	72,3	1,5	96,4	1,5	393,9 cm

KWALITEIT IN DETAIL

- rugwanden: hardboard, ingefreesd
- Draaideuren met deuropening van 105° met scharnieren met dempers
- legplanken 22mm dik met metalen plankendragers
- Metalen kledingroede met metalen houders, 40 KG belastbaar
- Al het beslag is uit metaal en hoog belastbaar
- Optimaal uitlevergemak door reeds gemonteerde bijmeubelen

900794



Emissionsgeprüft
Schadstoffgeprüft
Regelmäßige
Produkt-
überwachung
www.tuv.com
ID 1111253053











Draaideurkasten b 33 cm, met kranslijst

Interieurindeling:

2 legplanken, 1 kledingroede per vak
Alle draaideuren incl. dempers







	Beschrijving	Afmetingen in cm	Art. nr.	
	Deurophanging rechts	B 33 H 220 D 58	100	
	Deurophanging rechts	B 33 H 240 D 58	101	
	Deurophanging rechts 1 spiegeldeur	B 33 H 220 D 58	102	
	Deurophanging rechts 1 spiegeldeur	B 33 H 240 D 58	103	
	Deurophanging links	B 33 H 220 D 58	258	
	Deurophanging links	B 33 H 240 D 58	259	
	Deurophanging links, 1 spiegeldeur	B 33 H 220 D 58	108	
	Deurophanging links, 1 spiegeldeur	B 33 H 240 D 58	260	
	Deurophanging rechts 3 laden	B 33 H 220 D 58	441	
	Deurophanging rechts 3 laden	B 33 H 240 D 58	442	
	Deurophanging links, 3 laden	B 33 H 220 D 58	443	
	Deurophanging links, 3 laden	B 33 H 240 D 58	444	



Draaideurkasten b 50 cm, met kranslijst

Interieurindeling:

2 legplanken, 1 kledingroede per vak
Alle draaideuren incl. dempers

	Beschrijving	Afmetingen in cm	Art. nr.	
 47,5	Deurophanging rechts	B 50 H 220 D 58	598	
	Deurophanging rechts	B 50 H 240 D 58	244	
 47,5	Deurophanging rechts 1 spiegeldeur	B 50 H 220 D 58	584	
	Deurophanging rechts 1 spiegeldeur	B 50 H 240 D 58	113	
 47,5	Deurophanging links	B 50 H 220 D 58	597	
	Deurophanging links	B 50 H 240 D 58	115	
 47,5	Deurophanging links, 1 spiegeldeur	B 50 H 220 D 58	583	
	Deurophanging links, 1 spiegeldeur	B 50 H 240 D 58	270	
 47,5	Deurophanging rechts 3 laden	B 50 H 220 D 58	445	
	Deurophanging rechts 3 laden	B 50 H 240 D 58	446	
 47,5	Deurophanging rechts 3 laden, 1 spiegeldeur	B 50 H 220 D 58	447	
	Deurophanging rechts 3 laden, 1 spiegeldeur	B 50 H 240 D 58	448	
 47,5	Deurophanging links, 3 laden	B 50 H 220 D 58	449	
	Deurophanging links, 3 laden	B 50 H 240 D 58	450	



Draaideurkasten b 50 cm, met kranslijst

Interieurindeling:

2 legplanken, 1 kledingroede per vak

Alle draaideuren incl. dempers

	Beschrijving	Afmetingen in cm	Art. nr.	
	Deurophanging links, 3 laden, 1 spiegeldeur	B 50 H 220 D 58	451	
	Deurophanging links, 3 laden, 1 spiegeldeur	B 50 H 240 D 58	452	











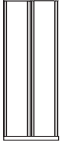

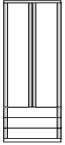
Luxor 3 & 4.



Draaideurkasten b 75 cm, met kranslijst

Interieurindeling:

2 legplanken, 1 kledingroede per vak
Alle draaideuren incl. dempers





	Beschrijving	Afmetingen in cm	Art. nr.	
 	2-deurs	B 75 H 220 D 58	118	
	2-deurs	B 75 H 240 D 58	119	
 	2-deurs, 3 laden	B 75 H 220 D 58	453	
	2-deurs, 3 laden	B 75 H 240 D 58	454	
 	2-deurs, 1 Spiegeldeur rechts	B 75 H 220 D 58	120	
	2-deurs, 1 Spiegeldeur rechts	B 75 H 240 D 58	121	
 	2-deurs, 1 spiegeldeur links	B 75 H 220 D 58	124	
	2-deurs, 1 spiegeldeur links	B 75 H 240 D 58	125	
 	2-deurs, 2 spiegeldeuren	B 75 H 220 D 58	128	
	2-deurs, 2 spiegeldeuren	B 75 H 240 D 58	129	
 	2 spiegeldeuren, 3 laden	B 75 H 220 D 58	455	
	2 spiegeldeuren, 3 laden	B 75 H 240 D 58	456	

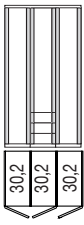
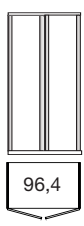

Draaideurkasten b 100 cm, met kranslijst

Interieurindeling:

2 legplanken, 1 kledingroede per vak
Alle draaideuren incl. dempers

	Beschrijving	Afmetingen in cm	Art. nr.	
	3-deurs, 3 laden	B 97 H 220 D 58	457	
	3-deurs, 3 laden	B 97 H 240 D 58	458	
	2-deurs	B 100 H 220 D 58	532	
	2-deurs	B 100 H 240 D 58	132	
	2-deurs, 1 Spiegeldeur rechts	B 100 H 220 D 58	392	
	2-deurs, 1 Spiegeldeur rechts	B 100 H 240 D 58	133	
	2-deurs, 1 spiegeldeur links	B 100 H 220 D 58	507	
	2-deurs, 1 spiegeldeur links	B 100 H 240 D 58	284	
	2 spiegeldeuren	B 100 H 220 D 58	391	
	2 spiegeldeuren	B 100 H 240 D 58	139	



Luxor 3 & 4.



Draaideurkasten b 125 - 133 cm, met kranlijst

Interieurindeling:

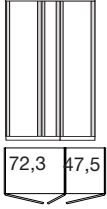
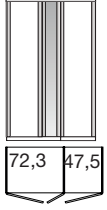
2 legplanken, 1 kledingroede per vak
Alle draaideuren incl. dempers

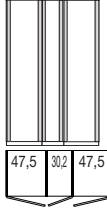
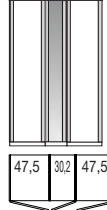
	Beschrijving	Afmetingen in cm	Art. nr.	
	3-deurs	B 125 H 220 D 58	141	
	3-deurs	B 125 H 240 D 58	142	
	3-deurs, 1 spiegeldeur	B 125 H 220 D 58	143	
	3-deurs, 1 spiegeldeur	B 125 H 240 D 58	144	
	3-deurs, 3 laden	B 133 H 220 D 58	459	
	3-deurs, 3 laden	B 133 H 240 D 58	460	
	3-deurs	B 133 H 220 D 58	147	
	3-deurs	B 133 H 240 D 58	148	
	3-deurs, 1 spiegeldeur	B 133 H 220 D 58	149	
	3-deurs, 1 spiegeldeur	B 133 H 240 D 58	150	

Luxor 3 & 4.



Draaideurkasten b 150 cm, met kranlijst

Interieurindeling:

2 legplanken, 1 kledingroede per vak
Alle draaideuren incl. dempers

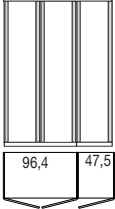
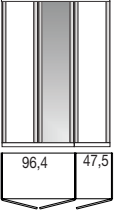
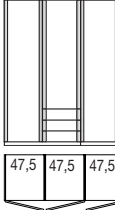
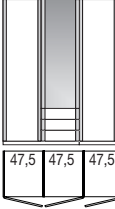
	Beschrijving	Afmetingen in cm	Art. nr.	
	3-deurs	B 150 H 220 D 58	531	
	3-deurs	B 150 H 240 D 58	153	
	3-deurs, 1 spiegeldeur	B 150 H 220 D 58	516	
	3-deurs, 1 spiegeldeur	B 150 H 240 D 58	285	
	3-deurs, 3 laden	B 150 H 220 D 58	854	
	3-deurs, 3 laden	B 150 H 240 D 58	497	
	3-deurs, 3 laden, 1 spiegeldeur	B 150 H 220 D 58	981	
	3-deurs, 3 laden, 1 spiegeldeur	B 150 H 240 D 58	498	

Luxor 3 & 4.



Draaideurkasten b 175 cm, met kranlijst

Interieurindeling:

2 legplanken, 1 kledingroede per vak
Alle draaideuren incl. dempers

	Beschrijving	Afmetingen in cm	Art. nr.	
	4-deurs	B 175 H 220 D 58	156	
	4-deurs	B 175 H 240 D 58	157	
	4-deurs, 2 spiegeldeuren	B 175 H 220 D 58	158	
	4-deurs, 2 spiegeldeuren	B 175 H 240 D 58	159	
	4-deurs, 3 laden	B 175 H 220 D 58	855	
	4-deurs, 3 laden	B 175 H 240 D 58	499	
	4-deurs, 2 spiegeldeuren, 3 laden	B 175 H 220 D 58	982	
	4-deurs, 2 spiegeldeuren, 3 laden	B 175 H 240 D 58	500	

Luxor 3 & 4.



Draaideurkasten b 200 cm, met kranslijst

Interieurindeling:

2 legplanken, 1 kledingroede per vak
Alle draaideuren incl. dempers

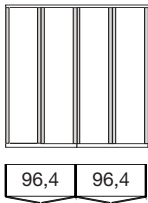
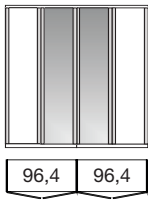
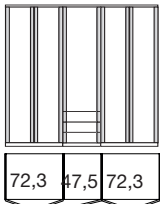
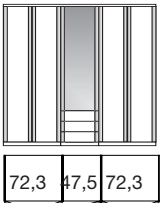
	Beschrijving	Afmetingen in cm	Art. nr.	
	4-deurs	B 200 H 220 D 58	534	
	4-deurs	B 200 H 240 D 58	162	
	4-deurs, 2 spiegeldeuren	B 200 H 220 D 58	517	
	4-deurs, 2 spiegeldeuren	B 200 H 240 D 58	163	
	5-deurs, 3 laden	B 200 H 220 D 58	501	
	5-deurs, 3 laden	B 200 H 240 D 58	502	
	5-deurs, 1 spiegeldeur, 3 laden	B 200 H 220 D 58	503	
	5-deurs, 1 spiegeldeur, 3 laden	B 200 H 240 D 58	504	

Luxor 3 & 4.



Draaideurkasten b 225 cm, met kranslijst

Interieurindeling:

2 legplanken, 1 kledingroede per vak
Alle draaideuren incl. dempers

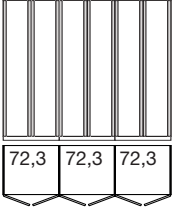
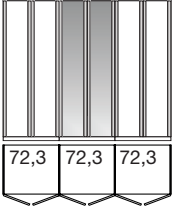
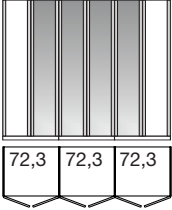
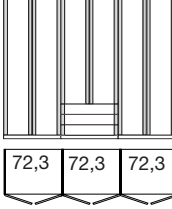
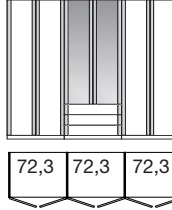
	Beschrijving	Afmetingen in cm	Art. nr.	
	6-deurs	B 225 H 220 D 58	165	
	6-deurs	B 225 H 240 D 58	166	
	6-deurs, 2 spiegeldeuren	B 225 H 220 D 58	167	
	6-deurs, 2 spiegeldeuren	B 225 H 240 D 58	168	
	6-deurs, 4 spiegeldeuren	B 225 H 220 D 58	171	
	6-deurs, 4 spiegeldeuren	B 225 H 240 D 58	172	
	6-deurs, 3 laden	B 225 H 220 D 58	505	
	6-deurs, 3 laden	B 225 H 240 D 58	506	
	6-deurs, 2 spiegeldeuren, 3 laden	B 225 H 220 D 58	508	
	6-deurs, 2 spiegeldeuren, 3 laden	B 225 H 240 D 58	509	

Luxor 3 & 4.



Draaideurkasten b 250 cm, met kranlijst

Interieurindeling:

2 legplanken, 1 kledingroede per vak
Alle draaideuren incl. dempers

	Beschrijving	Afmetingen in cm	Art. nr.	
	5-deurs	B 250 H 220 D 58	535	
	5-deurs	B 250 H 240 D 58	175	
	5-deurs, 1 spiegeldeur	B 250 H 220 D 58	521	
	5-deurs, 1 spiegeldeur	B 250 H 240 D 58	176	
	5-deurs, 2 spiegeldeuren	B 250 H 220 D 58	530	
	5-deurs, 2 spiegeldeuren	B 250 H 240 D 58	178	
	5-deurs, 3 spiegeldeuren	B 250 H 220 D 58	522	
	5-deurs, 3 spiegeldeuren	B 250 H 240 D 58	182	
	5-deurs, 3 laden	B 250 H 220 D 58	856	
	5-deurs, 3 laden	B 250 H 240 D 58	510	
	5-deurs, 1 spiegeldeur, 3 laden	B 250 H 220 D 58	983	
	5-deurs, 1 spiegeldeur, 3 laden	B 250 H 240 D 58	511	







Luxor 3 & 4.

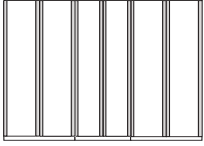

Draaideurkasten b 275 cm met kranslijst

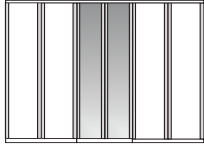
Interieurindeling:

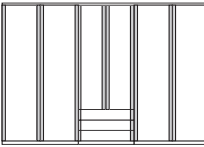
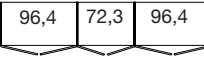
2 legplanken, 1 kledingroede per vak
Alle draaideuren incl. dempers

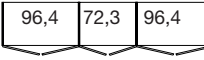
	Beschrijving	Afmetingen in cm	Art. nr.	
 	6-deurs	B 275 H 220 D 58	288	
	6-deurs	B 275 H 240 D 58	289	
 	6-deurs, 2 spiegeldeuren	B 275 H 220 D 58	290	
	6-deurs, 2 spiegeldeuren	B 275 H 240 D 58	291	
 	6-deurs, 3 laden	B 275 H 220 D 58	857	
	6-deurs, 3 laden	B 275 H 240 D 58	512	
 	6-deurs, 2 spiegeldeuren, 3 laden	B 275 H 220 D 58	979	
	6-deurs, 2 spiegeldeuren, 3 laden	B 275 H 240 D 58	513	

Luxor 3 & 4.



Draaideurkasten b 300 cm, met kranlijst

Interieurindeling:

2 legplanken, 1 kledingroede per vak
Alle draaideuren incl. dempers

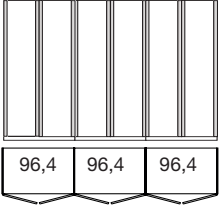
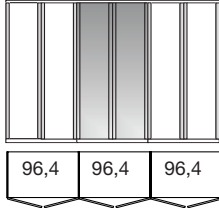
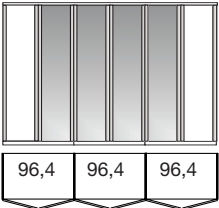
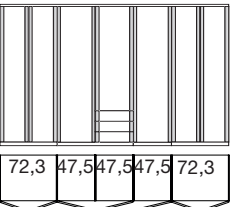
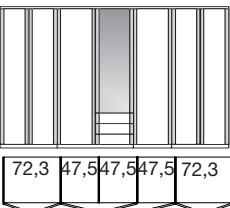
	Beschrijving	Afmetingen in cm	Art. nr.	
	6-deurs	B 300 H 220 D 58	536	
	6-deurs	B 300 H 240 D 58	292	
	6-deurs, 2 spiegeldeuren	B 300 H 220 D 58	527	
	6-deurs, 2 spiegeldeuren	B 300 H 240 D 58	293	
	6-deurs, 4 spiegeldeuren	B 300 H 220 D 58	533	
	6-deurs, 4 spiegeldeuren	B 300 H 240 D 58	295	
	7-deurs, 3 laden	B 300 H 220 D 58	514	
	7-deurs, 3 laden	B 300 H 240 D 58	515	
	7-deurs, 1 spiegeldeur, 3 laden	B 300 H 220 D 58	518	
	7-deurs, 1 spiegeldeur, 3 laden	B 300 H 240 D 58	519	





Luxor 3 & 4.

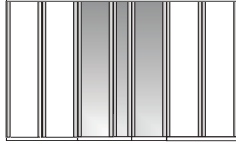

Draaideurkasten b 325 cm, met kranslijst

Interieurindeling:

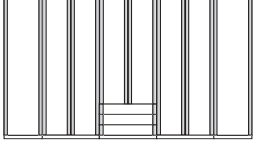
2 legplanken, 1 kledingroede per vak
Alle draaideuren incl. dempers

	Beschrijving	Afmetingen in cm	Art. nr.	
 96,4 72,3 47,5 96,4	7-deurs	B 325 H 220 D 58	352	
	7-deurs	B 325 H 240 D 58	353	
 96,4 72,3 47,5 96,4	7-deurs, 3 spiegeldeuren	B 325 H 220 D 58	354	
	7-deurs, 3 spiegeldeuren	B 325 H 240 D 58	355	
 96,4 72,3 47,5 96,4	7-deurs, 5 spiegeldeuren	B 325 H 220 D 58	201	
	7-deurs, 5 spiegeldeuren	B 325 H 240 D 58	203	
 47,5 72,3 72,3 72,3 47,5	8-deurs, 3 laden	B 325 H 220 D 58	520	
	8-deurs, 3 laden	B 325 H 240 D 58	523	
 47,5 72,3 72,3 72,3 47,5	8-deurs, 2 spiegeldeuren, 3 laden	B 325 H 220 D 58	524	
	8-deurs, 2 spiegeldeuren, 3 laden	B 325 H 240 D 58	525	

Luxor 3 & 4.



Draaideurkasten b 350 cm, met kranslijst

Interieurindeling:

2 legplanken, 1 kledingroede per vak
Alle draaideuren incl. dempers

	Beschrijving	Afmetingen in cm	Art. nr.	
	7-deurs	B 350 H 220 D 58	984	
	7-deurs	B 350 H 240 D 58	206	
	7-deurs, 1 spiegeldeur	B 350 H 220 D 58	988	
	7-deurs, 1 spiegeldeur	B 350 H 240 D 58	207	
	7-deurs, 3 spiegeldeuren	B 350 H 220 D 58	989	
	7-deurs, 3 spiegeldeuren	B 350 H 240 D 58	209	
	7-deurs, 5 spiegeldeuren	B 350 H 220 D 58	356	
	7-deurs, 5 spiegeldeuren	B 350 H 240 D 58	357	
	7-deurs, 3 laden	B 350 H 220 D 58	526	
	7-deurs, 3 laden	B 350 H 240 D 58	528	
	7-deurs, 1 spiegeldeur, 3 laden	B 350 H 220 D 58	541	
	7-deurs, 1 spiegeldeur, 3 laden	B 350 H 240 D 58	542	

Luxor 3 & 4.



Draaideurkasten b 375 cm, met kranlijst

Interieurindeling:

2 legplanken, 1 kledingroede per vak
Alle draaideuren incl. dempers

	Beschrijving	Afmetingen in cm	Art. nr.	
	8-deurs	B 375 H 220 D 58	358	
	8-deurs	B 375 H 240 D 58	359	
	8-deurs, 2 spiegeldeuren	B 375 H 220 D 58	360	
	8-deurs, 2 spiegeldeuren	B 375 H 240 D 58	361	
	8-deurs, 4 spiegeldeuren	B 375 H 220 D 58	370	
	8-deurs, 4 spiegeldeuren	B 375 H 240 D 58	371	
	8-deurs, 6 spiegeldeuren	B 375 H 220 D 58	225	
	8-deurs, 6 spiegeldeuren	B 375 H 240 D 58	226	
	8-deurs, 3 laden	B 375 H 220 D 58	543	
	8-deurs, 3 laden	B 375 H 240 D 58	544	
	8-deurs, 2 spiegeldeuren, 3 laden	B 375 H 220 D 58	545	
	8-deurs, 2 spiegeldeuren, 3 laden	B 375 H 240 D 58	546	









Luxor 3 & 4.

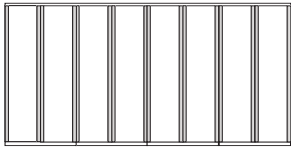
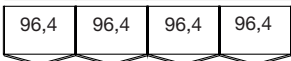

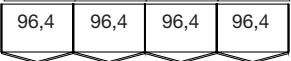
Draaideurkasten b 400 cm, met kranlijst

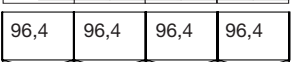
Interieurindeling:

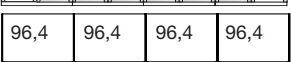
2 legplanken, 1 kledingroede per vak
Alle draaideuren incl. dempers

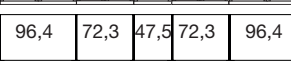
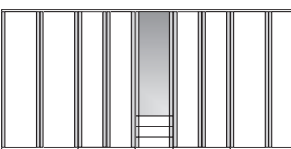
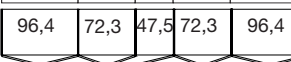
	Beschrijving	Afmetingen in cm	Art. nr.	
 	8-deurs	B 400 H 220 D 58	334	
	8-deurs	B 400 H 240 D 58	379	
 	8-deurs, 2 spiegeldeuren	B 400 H 220 D 58	338	
	8-deurs, 2 spiegeldeuren	B 400 H 240 D 58	374	
 	8-deurs, 4 spiegeldeuren	B 400 H 220 D 58	339	
	8-deurs, 4 spiegeldeuren	B 400 H 240 D 58	376	
 	8-deurs, 6 spiegeldeuren	B 400 H 220 D 58	233	
	8-deurs, 6 spiegeldeuren	B 400 H 240 D 58	234	
 	9-deurs, 3 laden	B 400 H 220 D 58	547	
	9-deurs, 3 laden	B 400 H 240 D 58	548	
 	9-deurs, 1 spiegeldeur, 3 laden	B 400 H 220 D 58	549	
	9-deurs, 1 spiegeldeur, 3 laden	B 400 H 240 D 58	550	



Hoekkast met kranslijst

Interieurindeling:



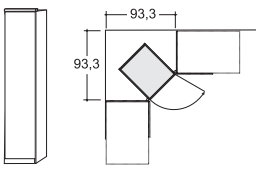
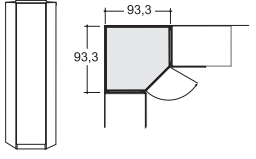
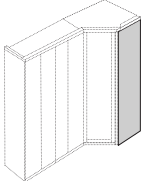

2 legplanken, 1 kledingroede per vak
Alle draaideuren incl. dempers

Beschrijving	Afmetingen in cm			Art. nr.	
	B	H	D		
 <p>hoekkast met draaideur, met en zonder spiegeldeur</p> <p>rechts aangeslagen met houten deur rechts aangeslagen met spiegeldeur</p> <p>links aangeslagen met houten deur links aangeslagen met spiegeldeur</p>	50	220	58	154	
	50	220	58	155	
	50	220	58	930	
	50	220	58	931	
	50	240	58	733	
	50	240	58	734	
	50	240	58	936	
	50	240	58	937	
 <p>uitgebouwde hoekkast met draaideur, met of zonder spiegel</p> <p>Interieurindeling: 1 legplank, 1 kledingroede</p> <p>rechts aangeslagen met houten deur rechts aangeslagen met spiegeldeur</p> <p>links aangeslagen met houten deur links aangeslagen met spiegeldeur</p>	93	220	93	184	
	93	220	93	185	
	93	220	93	934	
	93	220	93	935	
	93	240	93	735	
	93	240	93	736	
	93	240	93	938	
	93	240	93	939	
 <p>Afsluitende wand voor uitgebreide hoekkast, kan aan beide zijden (links en rechts) worden gebruikt</p>	56	216	1,5	090	
	56	236	1,5	738	
	<p>Is noodzakelijk, wanneer er geëindigd wordt met een uitgebreide hoekkast. Als een hoekkast apart wordt geplaatst, zijn 2 buitenwanden noodzakelijk.</p>				

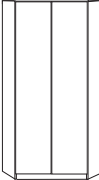

Hoekkast met kranlijst

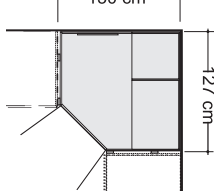

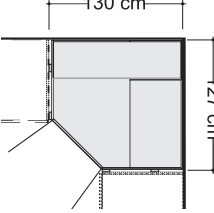
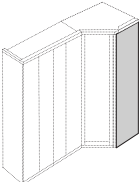

Alle draaideuren incl. dempers

Beschrijving	Afmetingen in cm			Art. nr.	
	B	H	D		
    	Inloop-hoekkast met draaideuren				
	met houten deur	130	220	127	021
	met spiegeldeur	130	220	127	022
	met houten deur	130	240	127	739
	met spiegeldeur	130	240	127	740
	Interieurindeling:				
	B 47,5 cm: 4 legplanken				
	B 72,2 cm: 2 legplanken, 1 kledingroede				
	Binnenspiegel, Verlichting met bewegingsmelder				
	Dit product bevat een lichtbron van energie-efficiëntieklasse G				
met houten deur met spiegeldeur					
130	220	127	020		
130	220	127	027		
met houten deur met spiegeldeur					
130	240	127	803		
130	240	127	814		
Interieurindeling:					
B 72,2 cm: 2 legplanken, 1 kledingroede					
B 125 cm: 5 legplanken, Verlichting met bewegingsmelder					
Dit product bevat een lichtbron van energie-efficiëntieklasse G					
	Afsluitende wand voor hoekkast, kan aan beide zijden (links en rechts) worden gebruikt				
	56	216	1,5	023	
	56	236	1,5	741	
Is noodzakelijk, wanneer er geëindigd wordt met een uitgebouwde hoekkast. Als een hoekkast apart wordt geplaatst, zijn 2 buitenwanden noodzakelijk.					

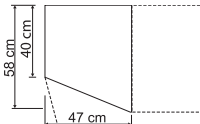
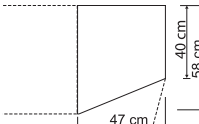

Bijpassende elementen

Alle draaideuren incl. dempers

Beschrijving	Afmetingen in cm			Art. nr.
	B	H	D	
 <p>hoeklijst voor hoekombouw 90°</p>				
	10	216	10	199
	10	236	10	737
 <p>Niet leverbaar in decor imitatie Lariks! Niet in gedeeltelijk-massief steeneiken leverbaar!</p>				
 <p>Afsluitkast met draaideur, afgeschuind, binnen 4 legplanken</p> <p>rechts te plaatsen</p> <p>links te plaatsen</p> <p>rechts te plaatsen</p> <p>links te plaatsen</p>	47	220	58	180
	47	220	58	181
	47	240	58	742
	47	240	58	743
 <p>Art. nr. 181 / 743</p>	 <p>Art. nr. 180 / 742</p>			
 <p>Kan niet los worden geplaatst!</p>				



Anbau an ausgebauten Eckschrank nur in Kombination mit Abschlusseite möglich!



Bedbovenbouw-combinaties

Alle draaideuren incl. dempers

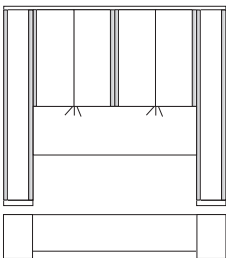
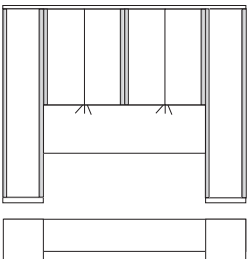
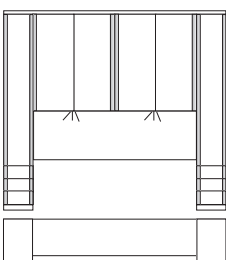

Bettbrücken-Falttören ohne Dämpfung

Beschrijving	Afmetingen in cm			Art. nr.
	B	H	D	
 <p>Combinatiesuggestie 1 met losse garderobekasten 33 cm, rechte deuren</p> <ul style="list-style-type: none"> - voor bedbreedte 140 cm - voor bedbreedte 160 cm - voor bedbreedte 180 cm - voor bedbreedte 200 cm 	215	220	58	030
	235	220	58	093
	255	220	58	094
	275	220	58	215
	<p>Interieurindeling</p> <p>Bedombouw: 2 legplanken</p> <p>Losse kledingkast: 2 legplanken 1 kledingroede</p>			
 <p>Combinatiesuggestie 2 met losse garderobekasten 50 cm, rechte deuren</p> <ul style="list-style-type: none"> - voor bedbreedte 140 cm - voor bedbreedte 160 cm - voor bedbreedte 180 cm - voor bedbreedte 200 cm 	250	220	58	116
	270	220	58	130
	290	220	58	134
	310	220	58	136
	<p>Interieurindeling</p> <p>Bedombouw: 2 legplanken</p> <p>Losse kledingkast: 2 legplanken 1 kledingroede</p>			
 <p>Combinatiesuggestie 3 met losse garderobekasten 33 cm, lades, rechte deuren</p> <ul style="list-style-type: none"> - voor bedbreedte 140 cm - voor bedbreedte 160 cm - voor bedbreedte 180 cm - voor bedbreedte 200 cm 	215	220	58	040
	235	220	58	041
	255	220	58	046
	275	220	58	051
	<p>Interieurindeling</p> <p>Bedombouw: 2 legplanken</p> <p>Losse kledingkast: 2 legplanken 1 kledingroede</p>			
<p>Dit product bevat lichtbronnen van energie-efficiëntieklasse F</p>				



Bedbovenbouw-combinaties

Alle draaideuren incl. dempers

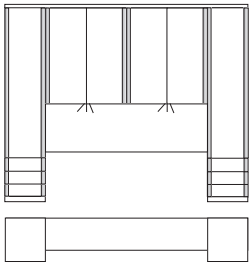
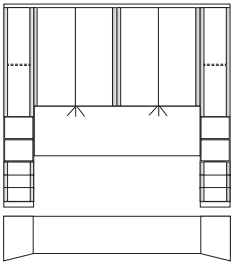
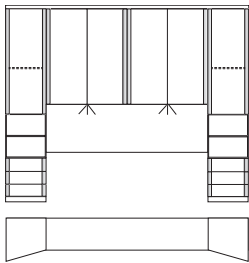

Bettbrücken-Falttören ohne Dämpfung

Beschrijving	Afmetingen in cm			Art. nr.
	B	H	D	
 <p>Combinatiesuggestie 4 met losse garderobekasten 50 cm, lades, rechte deuren</p> <p>- voor bedbreedte 140 cm - voor bedbreedte 160 cm - voor bedbreedte 180 cm - voor bedbreedte 200 cm</p> <p>Interieurindeling Bedombouw: 2 legplanken Losse kledingkast: 2 legplanken 1 kledingroede</p>	250	220	58	054
	270	220	58	057
	290	220	58	060
	310	220	58	061
	250	240	58	759
 <p>Combinatiesuggestie 5 met los elementen 33 cm, 3 lades, daarboven open vak met houten deuren, schuin geplaatst</p> <p>- voor bedbreedte 140 cm - voor bedbreedte 160 cm - voor bedbreedte 180 cm - voor bedbreedte 200 cm</p> <p>Interieurindeling Bedombouw: 2 legplanken Los element: 2 legplanken</p>	215	220	58	072
	235	220	58	074
	255	220	58	076
	275	220	58	077
	215	240	58	763
 <p>Combinatiesuggestie 6 met los elementen 50 cm, 3 lades, daarboven open vak met houten deuren, schuin geplaatst</p> <p>- voor bedbreedte 140 cm - voor bedbreedte 160 cm - voor bedbreedte 180 cm - voor bedbreedte 200 cm</p> <p>Interieurindeling Bedombouw: 2 legplanken Los element: 2 legplanken</p>	250	220	58	080
	270	220	58	081
	290	220	58	082
	310	220	58	083
	250	240	58	770
270	240	58	771	
290	240	58	772	
310	240	58	773	

Dit product bevat lichtbronnen van energie-efficiëntieklasse F



Bedbovenbouw-combinaties

Alle draaideuren incl. dempers

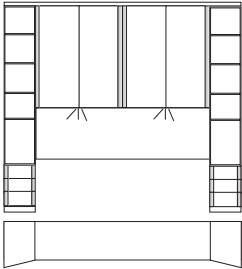
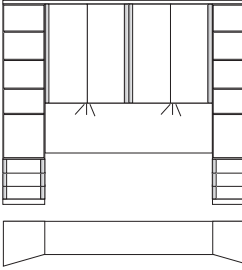
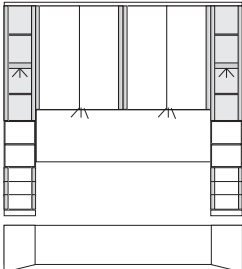

Bettbrücken-Falttören ohne Dämpfung

Beschrijving	Afmetingen in cm			Art. nr.		
	B	H	D			
 <p>Combinatiesuggestie 7 met los elementen 33 cm, 3 lades, daarboven open kast, schuin geplaatst</p> <p>- voor bedbreedte 140 cm - voor bedbreedte 160 cm - voor bedbreedte 180 cm - voor bedbreedte 200 cm</p>	215	220	58	774		
	235	220	58	775		
	255	220	58	776		
	275	220	58	777		
<p>Interieurindeling Bedombouw: 2 legplanken</p> <p>Los element: 4 legplanken</p> <p>- voor bedbreedte 140 cm - voor bedbreedte 160 cm - voor bedbreedte 180 cm - voor bedbreedte 200 cm</p>	215	240	58	778		
	235	240	58	779		
	255	240	58	780		
	275	240	58	781		
 <p>Combinatiesuggestie 8 met los elementen 50 cm, 3 lades, daarboven open kast, schuin geplaatst</p> <p>- voor bedbreedte 140 cm - voor bedbreedte 160 cm - voor bedbreedte 180 cm - voor bedbreedte 200 cm</p>	250	220	58	792		
	270	220	58	793		
	290	220	58	794		
	310	220	58	795		
<p>Interieurindeling Bedombouw: 2 legplanken</p> <p>Los element: 4 legplanken</p> <p>- voor bedbreedte 140 cm - voor bedbreedte 160 cm - voor bedbreedte 180 cm - voor bedbreedte 200 cm</p>	250	240	58	796		
	270	240	58	797		
	290	240	58	798		
	310	240	58	799		
 <p>Combinatiesuggestie 9 met los elementen 33 cm, 3 lades, daarboven open vak met glazen deuren, schuin geplaatst</p> <p>- voor bedbreedte 140 cm - voor bedbreedte 160 cm - voor bedbreedte 180 cm - voor bedbreedte 200 cm</p>	215	220	58	105		
	235	220	58	106		
	255	220	58	107		
	275	220	58	109		
<p>Interieurindeling Bedombouw: 2 legplanken</p> <p>Los element: 2 glasplaten 1 legplank</p> <p>- voor bedbreedte 140 cm - voor bedbreedte 160 cm - voor bedbreedte 180 cm - voor bedbreedte 200 cm</p>	215	240	58	800		
	235	240	58	801		
	255	240	58	802		
	275	240	58	804		
<p>Dit product bevat lichtbronnen van energie-efficiëntieklasse F</p>						



Bedbovenbouw-combinaties

Alle draaideuren incl. dempers



Bettbrücken-Falttören ohne Dämpfung

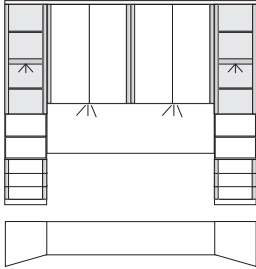
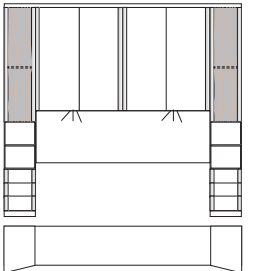
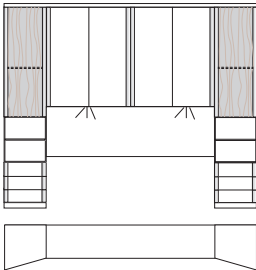



Beschrijving	Afmetingen in cm			Art. nr.
	B	H	D	
 <p>Combinatiesuggestie 10 met los elementen 50 cm, 3 lades, daarboven open vak met glazen deuren, schuin geplaatst</p> <p>- voor bedbreedte 140 cm - voor bedbreedte 160 cm - voor bedbreedte 180 cm - voor bedbreedte 200 cm</p>	250	220	58	110
	270	220	58	111
	290	220	58	112
	310	220	58	114
	Interieurindeling			
Bedombouw: 2 legplanken	250	240	58	850
Los element: 2 glasplaten 1 legplank	270	240	58	851
	290	240	58	852
	310	240	58	853
 <p>Combinatiesuggestie 11 met bijstelelementen 33 cm, onder 3 laden, daarboven open vak met deuren in structuur, schuin</p> <p>- voor bedbreedte 140 cm - voor bedbreedte 160 cm - voor bedbreedte 180 cm - voor bedbreedte 200 cm</p>	215	220	58	313
	235	220	58	314
	255	220	58	315
	275	220	58	316
	Interieurindeling			
Bedombouw: 2 legplanken	215	240	58	317
Los element: 2 legplanken	235	240	58	318
	255	240	58	321
	275	240	58	322
 <p>Combinatiesuggestie 12 met bijstelelementen 50 cm, onder 3 laden, daarboven open vak met deuren in structuur, schuin</p> <p>- voor bedbreedte 140 cm - voor bedbreedte 160 cm - voor bedbreedte 180 cm - voor bedbreedte 200 cm</p>	250	220	58	323
	270	220	58	325
	290	220	58	326
	310	220	58	331
	Interieurindeling			
Bedombouw: 2 legplanken	250	240	58	332
Los element: 2 legplanken	270	240	58	333
	290	240	58	335
	310	240	58	336

Dit product bevat lichtbronnen van energie-efficiëntieklasse F



losse elementen voor de bedbrug



Alle draaideuren incl. dempers

Beschrijving	Afmetingen in cm			Art. nr.	
	B	H	D		
  Interieurindeling: 2 legplanken, 1 kledingroede per vak	Bijstel kledingkast met rechte deur				
	Deur, links aangeslagen	33	220	58	186
	Deur, rechts aangeslagen	33	220	58	187
	Deur, links aangeslagen	33	240	58	805
	Deur, rechts aangeslagen	33	240	58	806
	Deur, links aangeslagen	50	220	58	568
	Deur, rechts aangeslagen	50	220	58	569
	Deur, links aangeslagen	50	240	58	807
	Deur, rechts aangeslagen	50	240	58	808
	  Interieurindeling: 2 legplanken, 1 kledingroede per vak	Bijstel kledingkast met rechte deur en 3 laden			
Deur, links aangeslagen		33	220	58	190
Deur, rechts aangeslagen		33	220	58	191
Deur, links aangeslagen		33	240	58	809
Deur, rechts aangeslagen		33	240	58	810
Deur, links aangeslagen		50	220	58	194
Deur, rechts aangeslagen		50	220	58	195
Deur, links aangeslagen		50	240	58	811
Deur, rechts aangeslagen		50	240	58	812
 Interieurindeling: 2 legplanken		Bijstelelement, onder 3 laden, daarboven open vak, houten deur afgeschuimt			
	links te plaatsen	33	220	58	192
	rechts te plaatsen	33	220	58	193
	links te plaatsen	33	240	58	813
	rechts te plaatsen	33	240	58	815
	links te plaatsen	50	220	58	196
	rechts te plaatsen	50	220	58	197
	links te plaatsen	50	240	58	819
	rechts te plaatsen	50	240	58	820









losse elementen voor de bedbrug

Alle draaideuren incl. dempers

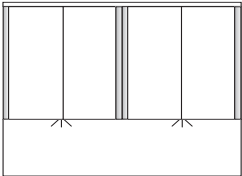
Beschrijving	Afmetingen in cm			Art. nr.		
	B	H	D			
 <p>Beistellelement, unten 3 Auszüge darüber offenes Fach, Tür in Struktur schräg gestellt</p>	links te plaatsen	33	220	58	396	
	rechts te plaatsen	33	220	58	397	
	links te plaatsen	33	240	58	398	
	rechts te plaatsen	33	240	58	399	
	Interieurindeling: 2 legplanken	links te plaatsen	50	220	58	400
		rechts te plaatsen	50	220	58	401
	links te plaatsen	50	240	58	402	
	rechts te plaatsen	50	240	58	403	
 <p>Bijstelelement, schuin geplaatst, onder 3 laden, daarboven doorgaand een open regaal</p>	links te plaatsen	33	220	58	822	
	rechts te plaatsen	33	220	58	825	
	links te plaatsen	33	240	58	828	
	rechts te plaatsen	33	240	58	829	
	Interieurindeling: 4 legplanken	links te plaatsen	50	220	58	826
		rechts te plaatsen	50	220	58	827
	links te plaatsen	50	240	58	830	
	rechts te plaatsen	50	240	58	831	
 <p>Bijstelelement, schuin gesplaatst, onder 3 laden daarboven open vak met helderen glasdeur</p>	links te plaatsen	33	220	58	177	
	rechts te plaatsen	33	220	58	198	
	links te plaatsen	33	240	58	832	
	rechts te plaatsen	33	240	58	833	
	Interieurindeling: 2 glasplaten 1 legplank	links te plaatsen	50	220	58	188
		rechts te plaatsen	50	220	58	189
	links te plaatsen	50	240	58	834	
	rechts te plaatsen	50	240	58	835	

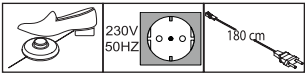
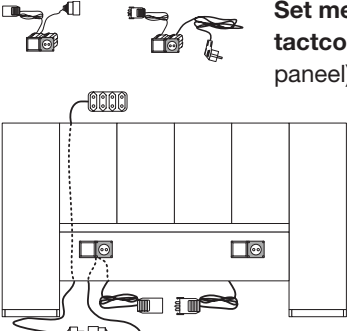

Bijpassende elementen voor bedbovenbouw-combinaties

Beschrijving	Afmetingen in cm			Art. nr.
	B	H	D	
 <p>Bedbrug met verlichting en paneel</p> <ul style="list-style-type: none"> - voor bedbreedte 140 cm - voor bedbreedte 160 cm - voor bedbreedte 180 cm - voor bedbreedte 200 cm <p>Interieurindeling bedbovenbouw: 2 legplanken</p> <p>Dit product bevat lichtbronnen van energie-efficiëntieklasse F</p>  	149	164	40	217
	169	164	40	218
	189	164	40	219
	209	164	40	220
	149	183	40	836
	169	183	40	837
	189	183	40	838
	209	183	40	839
 <p>Power-led-verlichting (set van 4) voor kranslijst boven bedbovenbouw</p> <p>Dit product bevat lichtbronnen van energie-efficiëntieklasse F</p> 	1	1	1	019
 <p>Set met 2 schakelaar- en stopcontactcombinaties (voor inbouw in paneel)</p> <p> Kan niet achteraf worden</p>	11	6	6	015
 <p>Verlichting (1 paar) voor paneel voor bedbovenbouw</p> <p>Dieses Produkt enthält eine Lichtquelle der Energieeffizienzklasse E</p>	1	1	1	413

Luxor 3 & 4.



Comfortbedden voor bedbovenbouw

4-voudige lighoogteverstelling

bedzijden hoogte 43 cm
Hoogte voeteneinde 46 cm

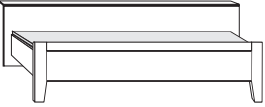
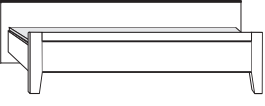
Beschrijving	Ligoppervlak	Steloppervlak	Art. nr.	
 <p>met boekenplank</p> <p>Hoogte hoofdeinde: 64 cm Hoogte voeteneinde: 46 cm Hoogte tot bovenkant bedzijde: 43 cm</p>	140 x 190	149 x 196	256	
	140 x 200	149 x 219	381	
	140 x 210	149 x 229	245	
	140 x 220	149 x 239	246	
	160 x 190	169 x 209	257	
	160 x 200	169 x 219	382	
	160 x 210	169 x 229	247	
	160 x 220	169 x 239	248	
	180 x 190	189 x 209	249	
	180 x 200	189 x 219	383	
	180 x 210	189 x 229	261	
	180 x 220	189 x 239	262	
	200 x 190	209 x 209	638	
	200 x 200	209 x 219	639	
	200 x 210	209 x 229	717	
	200 x 220	209 x 239	718	
 <p>Ruimtebesparend comfortbed</p> <p>Hoogte hoofdeinde: 62 cm Hoogte voeteneinde: 46 cm Hoogte tot bovenkant bedzijde: 43 cm</p>	140 x 190	149 x 196	431	
	140 x 200	149 x 206	432	
	140 x 210	149 x 216	916	
	140 x 220	149 x 226	440	
	160 x 190	169 x 196	463	
	160 x 200	169 x 206	464	
	160 x 210	169 x 216	495	
	160 x 220	169 x 226	496	
	180 x 190	189 x 196	467	
	180 x 200	189 x 206	468	
	180 x 210	189 x 216	469	
	180 x 220	189 x 226	470	
	200 x 190	209 x 196	823	
	200 x 200	209 x 206	232	
	200 x 210	209 x 216	243	
	200 x 220	209 x 226	253	

Luxor 3 & 4.



Comfortbedden voor bedbovenbouw

4-voudige lighoogteverstelling

bedzijden hoogte 43 cm
Hoogte voeteneinde 46 cm

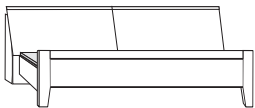
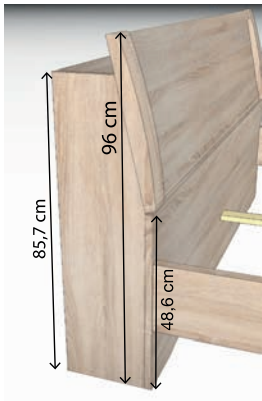
Beschrijving	Ligoppervlak	Steloppervlak	Art. nr.	
 <p>met bedkast in hoofdeinde</p> <p>Hoogte hoofdeinde: 95 cm Hoogte voeteneinde: 46 cm Hoogte tot bovenkant bedzijde: 43 cm</p> 	140 x 190 140 x 200 140 x 210 140 x 220	149 x 225 149 x 235 149 x 245 149 x 255	263 229 240 250	
	160 x 190 160 x 200 160 x 210 160 x 220	169 x 225 169 x 235 169 x 245 169 x 255	227 230 241 251	
	180 x 190 180 x 200 180 x 210 180 x 220	189 x 225 189 x 235 189 x 245 189 x 255	228 231 242 252	
	200 x 190 200 x 200 200 x 210 200 x 220	209 x 225 209 x 235 209 x 245 209 x 255	266 824 863 864	



Comfortbedden voor bedbovenbouw

4-voudige lighoogteverstelling

bedzijden hoogte 48cm
Hoogte voeteneinde 60 cm

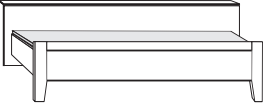
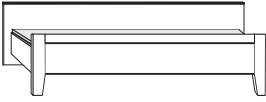
Beschrijving	Ligoppervlak	Steloppervlak	Art. nr.	
 <p>met boekenplank</p> <p>Hoogte hoofdeinde: 64 cm Hoogte voeteneinde: 60 cm Hoogte tot bovenkant bedzijde: 48 cm</p>	140 x 190	149 x 209	477	
	140 x 200	149 x 219	478	
	140 x 210	149 x 229	479	
	140 x 220	149 x 239	480	
	160 x 190	169 x 209	481	
	160 x 200	169 x 219	482	
	160 x 210	169 x 229	483	
	160 x 220	169 x 239	484	
	180 x 190	189 x 209	485	
	180 x 200	189 x 219	486	
	180 x 210	189 x 229	487	
	180 x 220	189 x 239	488	
	200 x 190	209 x 209	489	
	200 x 200	209 x 219	490	
	200 x 210	209 x 229	491	
	200 x 220	209 x 239	492	
 <p>Ruimtebesparend comfortbed</p> <p>Hoogte hoofdeinde: 62 cm Hoogte voeteneinde: 60 cm Hoogte tot bovenkant bedzijde: 48 cm</p>	140 x 190	149 x 196	493	
	140 x 200	149 x 206	494	
	140 x 210	149 x 216	599	
	140 x 220	149 x 226	600	
	160 x 190	169 x 196	601	
	160 x 200	169 x 206	602	
	160 x 210	169 x 216	603	
	160 x 220	169 x 226	604	
	180 x 190	189 x 196	605	
	180 x 200	189 x 206	606	
	180 x 210	189 x 216	607	
	180 x 220	189 x 226	608	
	200 x 190	209 x 196	609	
	200 x 200	209 x 206	612	
200 x 210	209 x 216	613		
200 x 220	209 x 226	614		

Luxor 3 & 4.



Comfortbedden voor bedbovenbouw

4-voudige lighoogteverstelling

bedzijden hoogte 48cm
Hoogte voeteneinde 60 cm

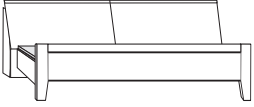
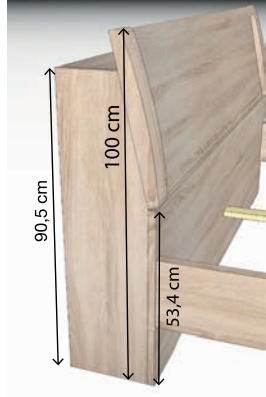
Beschrijving	Ligoppervlak	Steloppervlak	Art. nr.	
 <p>met bedkast in hoofdeinde</p> <p>Hoogte hoofdeinde: 100 cm Hoogte voeteneinde: 60 cm Hoogte tot bovenkant bedzijde: 48 cm</p> 	140 x 190	149 x 225	615	
	140 x 200	149 x 235	616	
	140 x 210	149 x 245	617	
	140 x 220	149 x 255	618	
	160 x 190	169 x 225	619	
	160 x 200	169 x 235	620	
	160 x 210	169 x 245	621	
	160 x 220	169 x 255	622	
	180 x 190	189 x 225	623	
	180 x 200	189 x 235	624	
	180 x 210	189 x 245	625	
	180 x 220	189 x 255	626	
	200 x 190	209 x 225	627	
	200 x 200	209 x 235	628	
	200 x 210	209 x 245	629	
	200 x 220	209 x 255	630	

Luxor 3 & 4.



Comfortbedden voor bedbovenbouw

4-voudige lighoogteverstelling

bedzijden hoogte 53 cm
Hoogte voeteneinde 65 cm

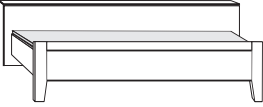
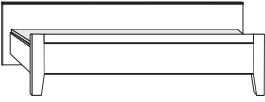
Beschrijving	Ligoppervlak	Steloppervlak	Art. nr.	
 <p>met boekenplank</p> <p>Hoogte hoofdeinde: 64 cm Hoogte voeteneinde: 65 cm Hoogte tot bovenkant bedzijde: 53 cm</p>	140 x 190	149 x 209	221	
	140 x 200	149 x 219	222	
	140 x 210	149 x 229	223	
	140 x 220	149 x 239	235	
	160 x 190	169 x 209	254	
	160 x 200	169 x 219	255	
	160 x 210	169 x 229	268	
	160 x 220	169 x 239	271	
	180 x 190	189 x 209	280	
	180 x 200	189 x 219	283	
	180 x 210	189 x 229	286	
	180 x 220	189 x 239	287	
	200 x 190	209 x 209	294	
	200 x 200	209 x 219	296	
	200 x 210	209 x 229	319	
	200 x 220	209 x 239	320	
 <p>Ruimtebesparend comfortbed</p> <p>Hoogte hoofdeinde: 62 cm Hoogte voeteneinde: 65 cm Hoogte tot bovenkant bedzijde: 53 cm</p>	140 x 190	149 x 196	337	
	140 x 200	149 x 206	346	
	140 x 210	149 x 216	347	
	140 x 220	149 x 226	349	
	160 x 190	149 x 196	351	
	160 x 200	169 x 206	362	
	160 x 210	169 x 216	363	
	160 x 220	169 x 226	366	
	180 x 190	189 x 196	368	
	180 x 200	189 x 206	372	
	180 x 210	189 x 216	373	
	180 x 220	189 x 226	375	
	200 x 190	209 x 196	384	
	200 x 200	209 x 206	385	
	200 x 210	209 x 216	386	
	200 x 220	209 x 226	387	

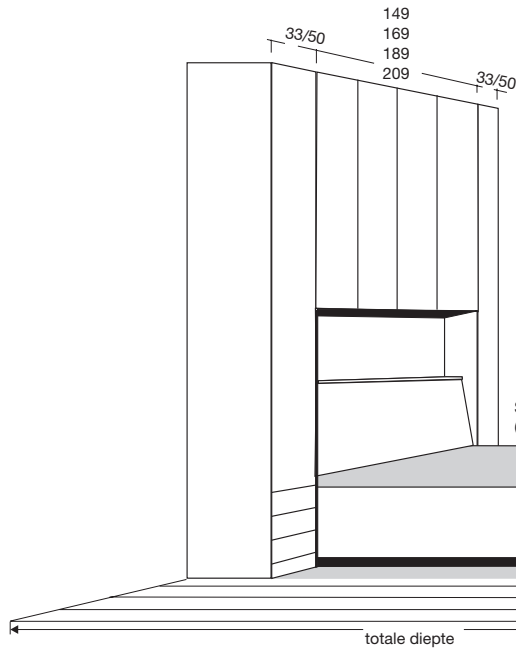

Bedbrugcombinatie met bergruimte in het hoofdbord

Bijvoorbeeld voor de voorstelling van de totale stelplaats
 Bedbrug B 189 cm (bij ligvlakte B 180 cm) + 2 x Bijstelement B 50 cm =
 totale breedte ca. 289 cm,
 totale diepte zie tekening

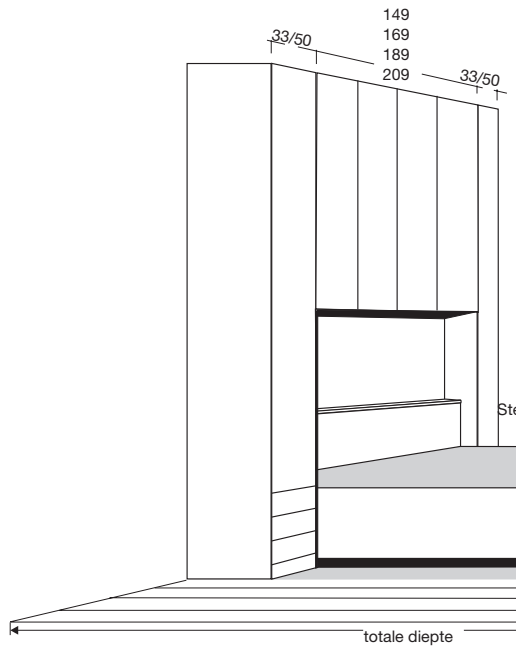
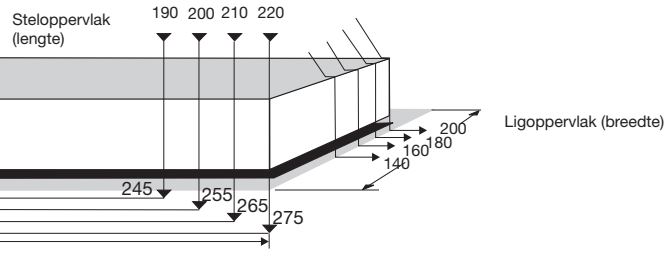

Bedbrugcombinatie met boekenplank

Bijvoorbeeld voor de voorstelling van de totale stelplaats
 Bedbrug B 169 cm (bij een bed van B 160 cm) +
 2 x los element B 33 cm =
 totale breedte ca. 235 cm,
 totale diepte zie tekening

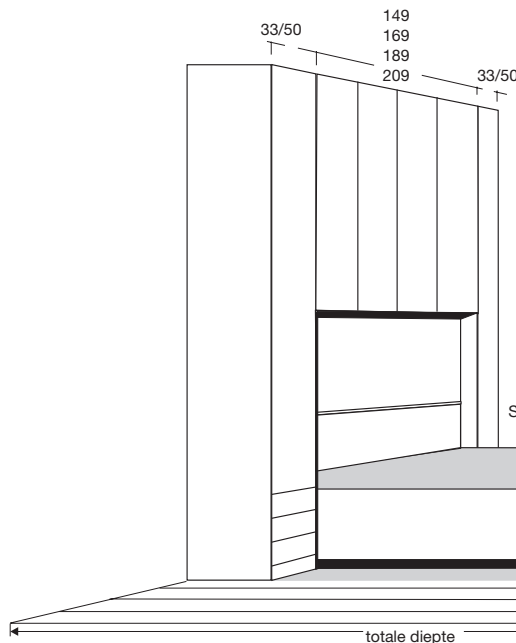
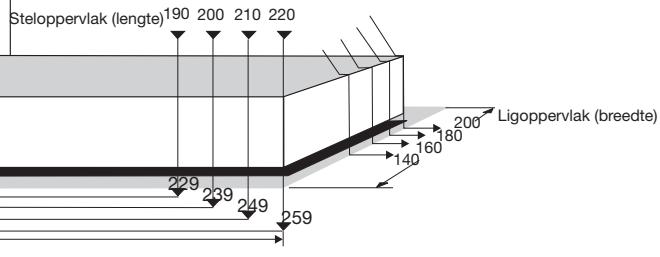

Ruimtebesparende bedbrugcombinatie



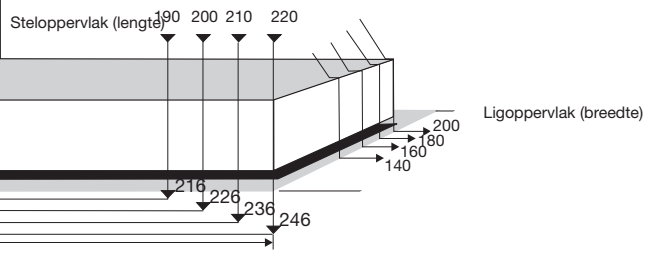

Bijvoorbeeld voor de voorstelling van de totale stelplaats
 Bedbrug B 209 cm (bij ligvlak B 200 cm) +
 1 x los element B 33 cm + 1 x los element B 50 cm
 = Totale breedte ca. 292 cm,
 totale diepte zie tekening



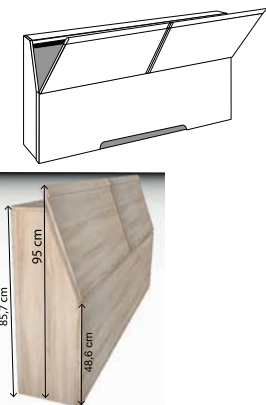
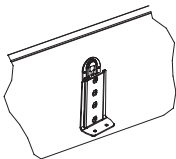

Bijpassende elementen voor comfortbedden

4-voudige lighoogteverstelling

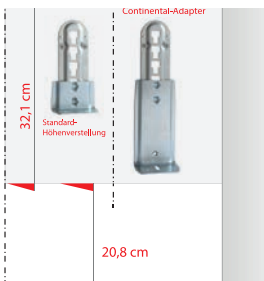
Beschrijving	Afmetingen in cm			Art. nr.
	B	H	D	
 <p>Gestoffeerd in kunstleder mocca voor hoorbordruimte met bergruimte</p> <ul style="list-style-type: none"> - voor bedbreedte 140 cm - voor bedbreedte 160 cm - voor bedbreedte 180 cm - voor bedbreedte 200 cm 	62	29	3,2	701
	72	29	3,2	702
	82	29	3,2	703
	92	29	3,2	704
 <p>Gestoffeerd in kunstleder antraciet voor hoorbordruimte met bergruimte</p> <ul style="list-style-type: none"> - voor bedbreedte 140 cm - voor bedbreedte 160 cm - voor bedbreedte 180 cm - voor bedbreedte 200 cm 	62	29	3,2	970
	72	29	3,2	971
	82	29	3,2	972
	92	29	3,2	973
 <p>Afdekljst voor bovenbouwnis, indien geen bed uit dit programma wordt gekozen.</p> <ul style="list-style-type: none"> - voor bedbreedte 140 cm - voor bedbreedte 160 cm - voor bedbreedte 180 cm - voor bedbreedte 200 cm 	149	62	5	917
	169	62	5	858
	189	62	5	859
	209	62	5	860
 <p>voor bedbrugniss, wanneer er geen ledikant uit dit programma nodig is.</p> <ul style="list-style-type: none"> - voor bedbreedte 140 cm - voor bedbreedte 160 cm - voor bedbreedte 180 cm - voor bedbreedte 200 cm 	149	95	30	645
	169	95	30	646
	189	95	30	647
	209	95	30	648
 <p>Continental-Adapter-Set voor het verhogen van inlegdiepte: - met 4,8 cm aan het bed hoogte 48 cm - met 9,6 cm aan het bed hoogte 53 cm</p> <p> Niet leverbaar voor bedden met bedzijden hoogte 43 cm!</p> 	1	1	1	881

Luxor 3 & 4.





comfortbedden vrij plaatsbaar

bedzijden hoogte 43 cm

Hoogte voeteneinde 46 cm

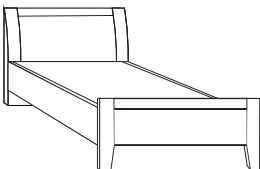
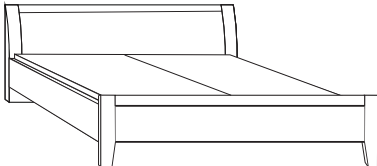
4-voudige lighoogteverstelling

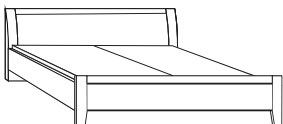
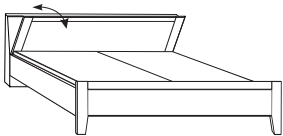
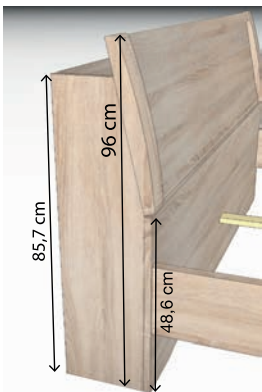
Beschrijving	Ligoppervlak	Steloppervlak	Art. nr.	
 <p>Met houten hoofdeinde, zonder bedkast</p>  <p>Hoogte hoofdeinde: 91 cm Hoogte voeteneinde: 46 cm Hoogte tot bovenkant bedzijde: 43 cm</p> <p> *bedbreedten 90, 100 en 120 cm niet in polar lariks en in steeneiken leverbaar!</p>	90 x 190 *	99 x 210	414	
	90 x 200	99 x 220	416	
	90 x 210	99 x 230	417	
	90 x 220	99 x 240	418	
	100 x 190*	109 x 210	421	
	100 x 200	109 x 220	422	
	100 x 210	109 x 230	423	
	100 x 220	109 x 240	424	
	120 x 190*	129 x 210	425	
	120 x 200	129 x 220	426	
	120 x 210	129 x 230	427	
	120 x 220	129 x 240	428	
	140 x 190	149 x 210	272	
	140 x 200	149 x 220	273	
	140 x 210	149 x 230	236	
	140 x 220	149 x 240	237	
160 x 190	169 x 210	429		
160 x 200	169 x 220	430		
160 x 210	169 x 230	435		
160 x 220	169 x 240	436		
180 x 190	189 x 210	437		
180 x 200	189 x 220	438		
180 x 210	189 x 230	439		
180 x 220	189 x 240	540		
200 x 190	209 x 210	551		
200 x 200	209 x 220	552		
200 x 210	209 x 230	553		
200 x 220	209 x 240	554		
 <p>Met houten hoofdeinde, en bergruimte in het hoofdbord</p>   <p>Hoogte hoofdeinde: 96 cm Hoogte voeteneinde: 46 cm Hoogte tot bovenkant bedzijde: 43 cm</p>	140 x 190	149 x 225	330	
	140 x 200	149 x 235	324	
	140 x 210	149 x 245	238	
	140 x 220	149 x 255	239	
	160 x 190	169 x 225	567	
	160 x 200	169 x 235	570	
	160 x 210	169 x 245	571	
	160 x 220	169 x 255	572	
	180 x 190	189 x 225	573	
	180 x 200	189 x 235	574	
	180 x 210	189 x 245	575	
	180 x 220	189 x 255	576	
	200 x 190	209 x 225	577	
	200 x 200	209 x 235	578	
	200 x 210	209 x 245	579	
	200 x 220	209 x 255	580	

Luxor 3 & 4.



comfortbedden vrij plaatsbaar

bedzijden hoogte 48 cm

Hoogte voeteneinde 60 cm

4-voudige lighoogteverstelling

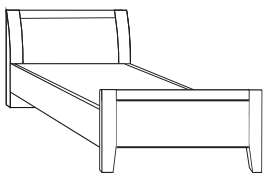
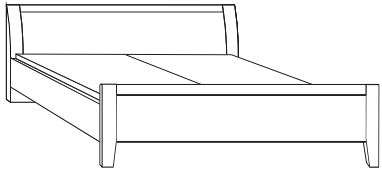
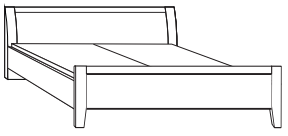
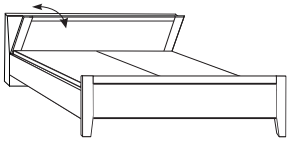
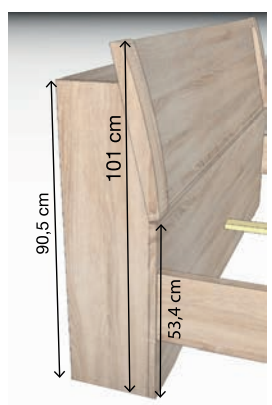
Beschrijving	Ligoppervlak	Steloppervlak	Art. nr.	
 <p>Met houten hoofdeinde, zonder bedkast</p>  <p>Hoogte hoofdeinde: 96 cm Hoogte voeteneinde: 60 cm Hoogte tot bovenkant bedzijde: 48 cm</p>	90 x 190	99 x 210	581	
	90 x 200	99 x 220	582	
	90 x 210	99 x 230	585	
	90 x 220	99 x 240	586	
	100 x 190	109 x 210	587	
	100 x 200	109 x 220	588	
	100 x 210	109 x 230	589	
	100 x 220	109 x 240	590	
	120 x 190	129 x 210	591	
	120 x 200	129 x 220	592	
	120 x 210	129 x 230	593	
	120 x 220	129 x 240	594	
	140 x 190	149 x 210	274	
	140 x 200	149 x 220	275	
	140 x 210	149 x 230	278	
	140 x 220	149 x 240	279	
160 x 190	169 x 210	700		
160 x 200	169 x 220	711		
160 x 210	169 x 230	712		
160 x 220	169 x 240	713		
180 x 190	189 x 210	714		
180 x 200	189 x 220	715		
180 x 210	189 x 230	716		
180 x 220	189 x 240	721		
200 x 190	209 x 210	722		
200 x 200	209 x 220	764		
200 x 210	209 x 230	767		
200 x 220	209 x 240	769		
 <p>Met houten hoofdeinde, en bergruimte in het hoofdbord</p>   <p>Hoogte hoofdeinde: 101 cm Hoogte voeteneinde: 60 cm Hoogte tot bovenkant bedzijde: 48 cm</p>	140 x 190	149 x 225	276	
	140 x 200	149 x 235	277	
	140 x 210	149 x 245	281	
	140 x 220	149 x 255	282	
	160 x 190	169 x 225	817	
	160 x 200	169 x 235	818	
	160 x 210	169 x 245	821	
	160 x 220	169 x 255	844	
	180 x 190	180 x 225	887	
	180 x 200	189 x 235	888	
	180 x 210	189 x 245	911	
	180 x 220	189 x 255	912	
	200 x 190	209 x 225	921	
	200 x 200	209 x 235	995	
	200 x 210	209 x 245	996	
	200 x 220	209 x 255	997	

Luxor 3 & 4.



comfortbedden vrij plaatsbaar



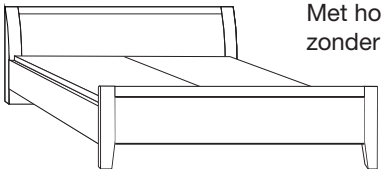
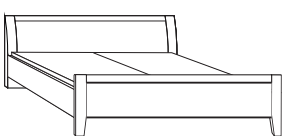
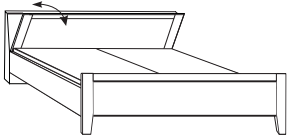
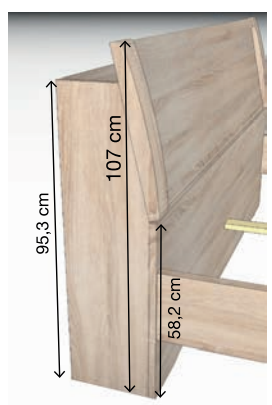

bedzijden hoogte 53 cm
Hoogte voeteneinde 65 cm

4-voudige lighoogteverstelling

Beschrijving	Ligoppervlak	Steloppervlak	Art. nr.	
 <p>Met houten hoofdeinde, zonder bedkast</p> <p>Hoogte hoofdeinde: 100 cm Hoogte voeteneinde: 65 cm Hoogte tot bovenkant bedzijde: 53 cm</p>	140 x 190	149 x 210	529	
	140 x 200	149 x 220	537	
	140 x 210	149 x 230	538	
	140 x 220	149 x 240	539	
	160 x 190	169 x 210	555	
	160 x 200	169 x 220	556	
	160 x 210	169 x 230	557	
	160 x 220	169 x 240	558	
	180 x 190	189 x 210	559	
	180 x 200	189 x 220	560	
	180 x 210	189 x 230	561	
	180 x 220	189 x 240	562	
	200 x 190	209 x 210	563	
	200 x 200	209 x 220	564	
	200 x 210	209 x 230	565	
	200 x 220	209 x 240	566	
 <p>Met houten hoofdeinde, en bergruimte in het hoofdbord</p>  <p>Hoogte hoofdeinde: 106 cm Hoogte voeteneinde: 65 cm Hoogte tot bovenkant bedzijde: 53 cm</p> 	140 x 190	149 x 225	595	
	140 x 200	149 x 235	596	
	140 x 210	149 x 245	678	
	140 x 220	149 x 255	679	
	160 x 190	169 x 225	680	
	160 x 200	169 x 235	681	
	160 x 210	169 x 245	664	
	160 x 220	169 x 255	665	
	180 x 190	189 x 225	666	
	180 x 200	189 x 235	667	
	180 x 210	189 x 245	668	
	180 x 220	189 x 255	669	
	200 x 190	209 x 225	670	
	200 x 200	209 x 235	671	
	200 x 210	209 x 245	672	
	200 x 220	209 x 255	673	

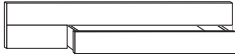
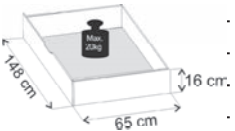

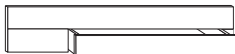
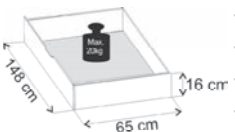



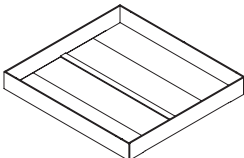

Bijpassende elementen voor comfortbedden

Beschrijving	Afmetingen in cm			Art. nr.
	B	H	D	
 Bedlade voor comfortbedden incl. bekleding van het voeteneinde, per paar				
 <ul style="list-style-type: none"> - voor ligoppervlak 140 x 190 cm - voor ligoppervlak 140 x 200 cm - voor ligoppervlak 140 x 210 cm - voor ligoppervlak 140 x 220 cm 	140	15	61	861
	140	15	61	364
	140	15	61	862
	140	15	61	365
	140	15	61	865
	140	15	61	367
	140	15	61	866
	140	15	61	369
 <ul style="list-style-type: none"> - voor bedzijden hoogte 43 cm - voor ligoppervlak 180 x 190 cm - voor ligoppervlak 180 x 200 cm - voor ligoppervlak 180 x 210 cm - voor ligoppervlak 180 x 220 cm 	140	15	61	867
	140	15	61	378
	140	15	61	868
	140	15	61	380
	140	15	61	869
	140	15	61	394
	140	15	61	870
	140	15	61	395
 Bedlade voor comfortbedden incl. bekleding van het voeteneinde, per paar				
 <ul style="list-style-type: none"> - voor ligoppervlak 140 x 190 cm - voor ligoppervlak 140 x 200 cm - voor ligoppervlak 140 x 210 cm - voor ligoppervlak 140 x 220 cm 	140	15	61	709
	140	15	61	710
	140	15	61	719
	140	15	61	720
	140	15	61	732
	140	15	61	744
	140	15	61	746
	140	15	61	782
 <ul style="list-style-type: none"> - voor bedzijden hoogte 48 en 53 cm - voor ligoppervlak 180 x 190 cm - voor ligoppervlak 180 x 200 cm - voor ligoppervlak 180 x 210 cm - voor ligoppervlak 180 x 220 cm 	140	15	61	783
	140	15	61	784
	140	15	61	785
	140	15	61	786
	140	15	61	787
	140	15	61	788
	140	15	61	789
	140	15	61	790







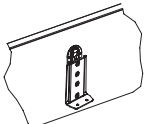

Bijpassende elementen voor comfortbedden

	Beschrijving	Afmetingen in cm			Art. nr.
		B	H	D	
 <p>Niet leverbaar voor bedbreedte 120 cm!</p>	onderbouw voor alle bedzijde hoogten				
	- voor ligoppervlak 90 x 190 cm	87	22	190	880
	- voor ligoppervlak 90 x 200 cm	87	22	190	882
	- voor ligoppervlak 90 x 210 cm	87	22	190	883
	- voor ligoppervlak 90 x 220 cm	87	22	190	884
	- voor ligoppervlak 100 x 190 cm	97	22	190	885
	- voor ligoppervlak 100 x 200 cm	97	22	190	886
	- voor ligoppervlak 100 x 210 cm	97	22	190	901
	- voor ligoppervlak 100 x 220 cm	97	22	190	902
	- voor ligoppervlak 140 x 190 cm	137	22	190	907
	- voor ligoppervlak 140 x 200 cm	137	22	190	908
	- voor ligoppervlak 140 x 210 cm	137	22	190	909
	- voor ligoppervlak 140 x 220 cm	137	22	190	910
	- voor ligoppervlak 160 x 190 cm	157	22	190	913
	- voor ligoppervlak 160 x 200 cm	157	22	190	918
	- voor ligoppervlak 160 x 210 cm	157	22	190	919
	- voor ligoppervlak 160 x 220 cm	157	22	190	920
	- voor ligoppervlak 180 x 190 cm	177	22	190	922
	- voor ligoppervlak 180 x 200 cm	177	22	190	923
	- voor ligoppervlak 180 x 210 cm	177	22	190	924
- voor ligoppervlak 180 x 220 cm	177	22	190	925	
- voor ligoppervlak 200 x 190 cm	197	22	190	926	
- voor ligoppervlak 200 x 200 cm	197	22	190	927	
- voor ligoppervlak 200 x 210 cm	197	22	190	928	
- voor ligoppervlak 200 x 220 cm	197	22	190	929	
 <p>Niet voor de bedbreedten 120 cm und 140 cm leverbaar!</p>	lattenbodem met scharnierbeslag voor bedlengte 200cm				
	- voor ligoppervlak 90 x 200 cm	90	9	200	871
	- voor ligoppervlak 100 x 200 cm	100	9	200	872
	- voor ligoppervlak 160 x 200 cm	2 x 80	9	200	873
	- voor ligoppervlak 180 x 200 cm	2 x 90	9	200	874
	- voor ligoppervlak 200 x 200 cm	2 x 100	9	200	875
  					
 	Hier finden Sie weitere Informationen				

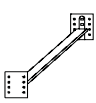
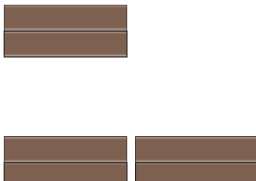

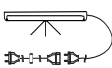



Bijpassende elementen voor comfortbedden

Beschrijving	Afmetingen in cm			Art. nr.
	B	H	D	
 <p>Continental-Adapter-Set voor het verhogen van inlegdiepte: - met 4,8 cm aan het bed hoogte 48 cm - met 9,6 cm aan het bed hoogte 53 cm</p> <p> Niet leverbaar voor bedden met bedzijden</p>	1	1	1	881
 <p>Vario beslag - hiermee kunnen twee eenpersoonsbedden omgevormd worden tot één geheel</p> <p>Voor bedlengte 190 cm Voor bedlengte 200 cm Voor bedlengte 210 cm voor bedlengte 220 cm</p>	6,5 6,5 6,5 6,5	2,5 2,5 2,5 2,5	190 200 210 220	705 706 707 708
 <p>Gestoffeerd hoofdeinde in kunstleer mocca</p> <p>- voor bedbreedte 90 cm - voor bedbreedte 100 cm - voor bedbreedte 120 cm</p> <p>- voor bedbreedte 140 cm - voor bedbreedte 160 cm - voor bedbreedte 180 cm - voor bedbreedte 200 cm</p>	82 92 112,4 62 72 82 92	29 29 29 29 29 29 29	3,2 3,2 3,2 3,2 3,2 3,2 3,2	697 698 699 701 702 703 704
 <p>Gestoffeerd hoofdbord in kunstleder antraciet</p> <p>- voor bedbreedte 90 cm - voor bedbreedte 100 cm - voor bedbreedte 120 cm</p> <p>- voor bedbreedte 140 cm - voor bedbreedte 160 cm - voor bedbreedte 180 cm - voor bedbreedte 200 cm</p>	82 92 112,4 62 72 82 92	29 29 29 29 29 29 29	3,2 3,2 3,2 3,2 3,2 3,2 3,2	966 968 969 970 971 972 973
 <p>Oriëntatieverlichting met bewegingsmelder, te bevestigen aan de bedzijden</p> <p>Dit product bevat een lichtbron van energie-efficiëntieklasse F</p> <p>Stuk Paar</p> <p> Niet leverbaar in combinatie met bedlades!</p>	21 21	2 2	1,7 1,7	640 641
 <p>LED-beugellamp voor futonbed in chroom</p> <p>Dit product bevat een lichtbron van energie-efficiëntieklasse F</p>	35	4	3	643

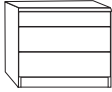

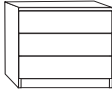
Nachtkastjes en panelen

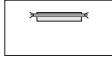
Beschrijving	Afmetingen in cm			Art. nr.
	B	H	D	
<p>Nachtkastje met 3 laden, bovenste lade smal</p>  <p>Stuk Paar</p>  <p>Stuk Paar</p>				
<p>- voor bedden met bedzijden hoogte 43/48 cm</p> <p></p>				
	40	50	37	915
	40	50	37	914
	60	50	37	610
	60	50	37	611
<p>Nachtkastje met 3 laden</p>  <p>Stuk Paar</p>  <p>Stuk Paar</p>				
<p>- voor bedden met bedzijden hoogte 53 cm</p> <p></p>				
	40	56	37	631
	40	56	37	632
	60	56	37	633
	60	56	37	651
<p>Nachtkastjepaneel, met glasplaat</p>  <p>stuks lks. stuks re. Paar</p> <p>stuks lks. stuks re. Paar</p>				
	40	20	12	652
	40	20	12	653
	40	20	12	654
	60	20	12	655
	60	20	12	656
	60	20	12	657
<p>Nachtkastjepaneel met glasplaat en led-verlichting</p>  <p>stuks lks. stuks re. Paar</p> <p>stuks lks. stuks re. Paar</p>				
	40	20	12	658
	40	20	12	659
	40	20	12	660
	60	20	12	661
	60	20	12	662
	60	20	12	663

Dit product bevat lichtbronnen van energie-efficiëntieklasse F



Losse meubelen

Alle draaideuren incl. dempers

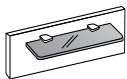
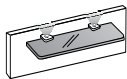
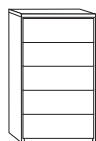
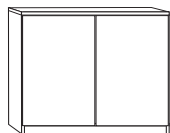
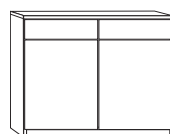

Beschrijving	Afmetingen in cm			Art. nr.	
	B	H	D		
 <p>Nachtkastjepaneel, met tablet in gefumeerd glas</p>	Stuk	40	20	12	104
	Paar	40	20	12	126
	Stuk	60	20	12	127
	Paar	60	20	12	131
	<hr/>				
 <p>Nachtkastjepaneel, met tablet in gefumeerd glas en led-verlichting</p>	Stuk	40	20	12	140
	Paar	40	20	12	145
	Stuk	60	20	12	146
	Paar	60	20	12	151
	<hr/>				
 <p>Ladekast</p>	40	89	37	889	
	60	89	37	685	
	93	89	37	845	
	<hr/>				
 <p>Commode 2-deurs, met doorlopende legplank</p>	93	89	37	062	
<hr/>					
 <p>commode, 2-deurs, 2 laden erboven</p>	93	89	37	684	

Dit product bevat lichtbronnen van energie-efficiëntieklasse G



Losse meubelen

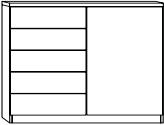
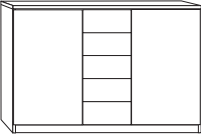

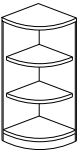



Alle draaideuren incl. dempers

Beschrijving	Afmetingen in cm			Art. nr.
	B	H	D	
 <p>Combi commode, smal, links 5 laden, 1 deur rechts aangeslagen, daarachter een legplank</p>	93	89	37	024
 <p>Combi commode, midden 5 laden, buiten 2 deuren, per deurvak een legplank</p>	125	89	37	419
 <p>Hoek commode</p> <p>rechts aangesl., links v.h. bed te plaatsen</p> <p>links aangesl., rechts v.h. bed te plaatsen</p>  <p>Altijd alleen ZONDER SIERLIJSTEN leverbaar (ook in PG 2)!</p>	61 61	89 89	61 61	686 688
 <p>Eindhoeck</p>	37	89	37	068

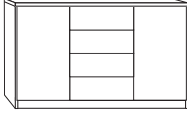
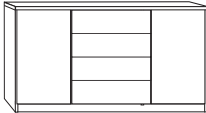

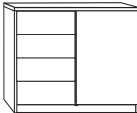
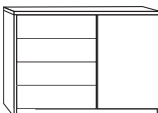
Losse meubelen, 4 laden, D 58 cm



Alle draaideuren incl. dempers

Beschrijving	Afmetingen in cm			Art. nr.
	B	H	D	
 <p>XXL combicommode 1 legplank per deur 4 laden</p>				
	150	83	58	840
 <p>+ 1 legplank</p>	175	83	58	841
	47,5	2,2	51,5	017
 laden met softclose				
 <p>XXL combicommode, smal 1 legplank 4 laden</p>				
	100	83	58	876
 <p>+ 1 legplank</p>	125	83	58	877
	47,5	2,2	51,5	017
 laden met softclose				
 <p>XXL-ladenkast 4 laden</p>				
	75	83	58	842
 laden met softclose				



Losse meubelen, D 58 cm

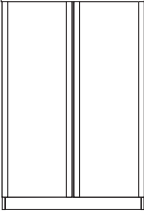
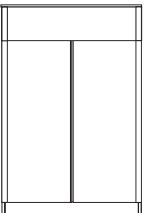

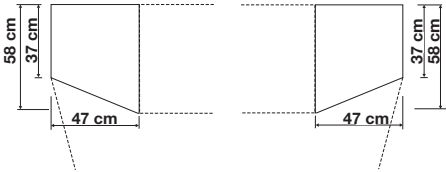
Alle draaideuren incl. dempers

Beschrijving	Afmetingen in cm			Art. nr.
	B	H	D	
 <p>commode met 2 deuren</p> <p>Interieurindeling: 1 legplank, 1 kledingroede</p> <p>+ 1 legplank</p>				
	100	125	58	903
	96,4	2,2	51,5	026
 <p>commode met 2 deuren en 1 lade</p> <p>Interieurindeling: 1 kledingroede</p> <p>+ 1 legplank</p>				
	100	125	58	904
	96,4	2,2	51,5	026
 <p>Afsluitelement voor commode, afgeschuind</p> <p>rechts te plaatsen</p> <p>links te plaatsen</p> <p>Interieurindeling: 2 legplanken</p> 				
	47	125	58	905
	47	125	58	906





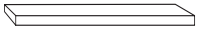
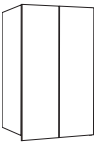
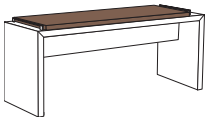



Losse meubelen

Alle draaideuren incl. dempers

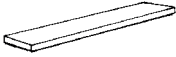
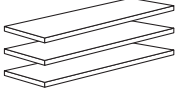
Beschrijving	Afmetingen in cm			Art. nr.
	B	H	D	
 <p>Steekschappen</p>	60 80 100 150 170 190	3 3 3 3 3 3	20 20 20 25 25 25	899 891 892 893 894 895
 <p>Hangkast met een legplank</p>	56	90	32	900
 <p>Aankleedbank met stoffering</p> <p>- met kunstleer in mokka - met kunstleer grafiet</p>	120 120	53 53	40 40	644 677
 <p>Wandspiegel</p>	60	80	3	087
 <p>hangspiegel verticaal of horizontaal te bevestigen</p>	110	85	3	086







Kast-accessoires Interieurindeling Treeline

Beschrijving	Afmetingen in cm			Art. nr.
	B	H	D	
 <p>1 legplank</p> <ul style="list-style-type: none"> - voor vakbreedte 30,2 cm - voor vakbreedte 47,5 cm - voor vakbreedte 72,2 cm - voor vakbreedte 96,4 cm 				
	30,2	2,2	51,5	016
	47,5	2,2	51,5	017
	72,3	2,2	51,5	018
	96,4	2,2	51,5	026
 <p>3 legplanken</p> <ul style="list-style-type: none"> - voor vakbreedte 30,2 cm - voor vakbreedte 47,5 cm - voor vakbreedte 72,2 cm - voor vakbreedte 96,4 cm 				
	30,2	2,2	51,5	034
	47,5	2,2	51,5	032
	72,3	2,2	51,5	033
	96,4	2,2	51,5	031
 <p>LED-Lichtlijst voorlegplanken</p> <ul style="list-style-type: none"> - voor vakbreedte 47,5 cm - voor vakbreedte 72,2 cm - voor vakbreedte 96,4 cm <p>set van 2</p> <ul style="list-style-type: none"> - voor vakbreedte 47,5 cm - voor vakbreedte 72,2 cm - voor vakbreedte 96,4 cm <p>set van 3</p> <ul style="list-style-type: none"> - voor vakbreedte 47,5 cm - voor vakbreedte 72,2 cm - voor vakbreedte 96,4 cm <p> Niet geschikt voor inloop-hoekkast!</p> <p>Dit product bevat een lichtbron van energie-efficiëntieklasse F</p>				
	47,5	3	1	682
	72,3	3	1	683
	96,4	3	1	689
	47,5	3	1	690
	72,3	3	1	691
	96,4	3	1	692
	47,5	3	1	693
	72,3	3	1	694
	96,4	3	1	695
 <p>1 legplank voor uitgebouwde hoekkast</p>	88	2,2	88	420
 <p>1 legplank voor commode met 2 deuren b 93 cm alleen voor art.nr. 062</p>	89	2,2	31	434
 <p>legplanken voor combicommode, per paar voor commode type</p>	44	2,2	31	433



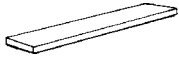

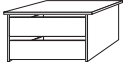
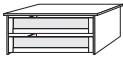
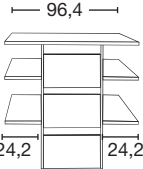
Kast-accessoires Interieurindeling Treeline

Beschrijving	Afmetingen in cm			Art. nr.
	B	H	D	
 <p>1 legplank voor eindkast, afgeschuind</p>	43	2,2	51,5	990
 <p>Kledingroede</p> <ul style="list-style-type: none"> - voor vakbreedte 30,2 cm - voor vakbreedte 47,5 cm - voor vakbreedte 72,2 cm - voor vakbreedte 96,4 cm 	30,2 47,5 72,3 96,4	1 1 1 1	1 1 1 1	088 035 036 037
 <p>legplanken voor bedbrug</p> <ul style="list-style-type: none"> - voor bedbreedte 140 cm - voor bedbreedte 160 cm - voor bedbreedte 180 cm - voor bedbreedte 200 cm 	71,4 81,4 91,4 101,4	2,2 2,2 2,2 2,2	36,5 36,5 36,5 36,5	067 010 066 377
 <p>1 legplank</p> <ul style="list-style-type: none"> - voor los element b 33 cm, schuin geplaatst - voor los element b 50 cm, schuin geplaatst 	33 50	2 2	53 53	028 029
 <p>Ladeblok met 2 laden</p> <p>Houten front</p> <ul style="list-style-type: none"> - voor vakbreedte 47,5 cm - voor vakbreedte 72,2 cm - voor vakbreedte 96,4 cm  <p>Glazen front</p> <ul style="list-style-type: none"> - voor vakbreedte 47,5 cm - voor vakbreedte 72,2 cm - voor vakbreedte 96,4 cm 	47,5 72,3 96,4	41 41 41	51,5 51,5 51,5	038 039 042 047 048 049
 <p>Ladenblok met 3 laden en houten front</p> <ul style="list-style-type: none"> - voor vakbreedte 96,4 cm 	96,4	89	51,5	123



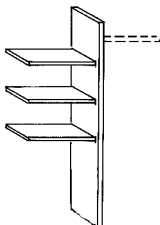
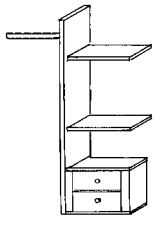

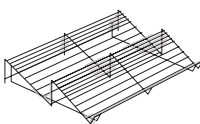
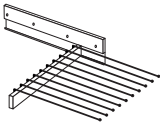
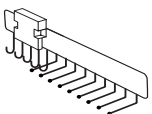

Kast-accessoires Interieurindeling Treeline

Beschrijving	Afmetingen in cm			Art. nr.
	B	H	D	
 <p>Wäscheboden-Einsatz</p> <ul style="list-style-type: none"> - voor vakbreedte 72,2 cm - voor vakbreedte 96,4 cm <p>Interieurindeling: 3 legplanken, 1 kledingroede, 1 middenzijde</p>	72,3 96,4	137 137	51,5 51,5	174 474
 <p>- voor vakbreedte 72,2 cm - voor vakbreedte 96,4 cm</p> <p>Interieurindeling: 2 laden, 2 legplanken 1 kledingroede, 1 middenzijde</p> <p> Aan beide zijden (links of rechts) te gebruiken! Alleen te plaatsen op de sokkel!</p>	72,3 96,4	137 137	51,5 51,5	179 475
 <p>Schoenenrooster</p>	96	15	50	055
 <p>Uitschuifbare broekhouder</p>	45	10	50	056
 <p>Uittrekbaar dassen- en riemenrek</p>	16	10	45	059

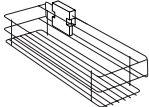

Kast-accessoires Interieurindeling Treeline

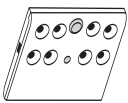
Beschrijving	Afmetingen in cm			Art. nr.
	B	H	D	
 <p>Bergrekje</p>	16	9	45	476
 <p>Dassen- en riemenhouder</p>	30	27	9	471
 <p>Binnenspiegel</p> <p> alleen voor de 50cm draaideuren leverbaar</p>	36	80	2	472
 <p>Kledinglift - alleen voor draaideurkasten</p> <p>- voor kastvakbreedten 72,2 - 96,4 cm</p>	100	85	14	473
 <p>LED-kastbinnenverlichting mer bewegingsmelder, inclusief accu (opladen via USB)</p> <p>1 stuk 10 2 10 264</p> <p>2 stuks 10 2 10 265</p> <p>3 stuks 10 2 10 267</p> <p>4 stuks 10 2 10 269</p>				