



**HTL - 2743** 2EL1VA + SQC + 2NA + COUR



**HTL - 2743** 2.5EL1XA + C + 1.5ERST



**HTL - 2743** 2EL1VA + COUR



**HTL - 2743** 3S2VE, 3S2VA





**HTL - 2743** 2.5S2X, 2.5S2XA



**HTL - 2743** 2EL + 1ERTC



**HTL - 2743** <sub>3S</sub>



RFSTA





**HTL - 2743** AC



RFSTA



**DIMENSION**

Configuration	Width		Depth		Seat Depth		Back Height		Seat Height		Weight		Volume	
	cm	inch	cm	inch	cm	inch	cm	inch	cm	inch	kg	lb	m <sup>3</sup>	ft <sup>3</sup>
3S2XE, 3S2XA	229	90	97 - 157	38 - 62	54	21	99	39	49	19	122	269	2.20	77.66
2.5S2X, 2.5S2XA	216	85	97 - 157	38 - 62	54	21	99	39	49	19	115	254	2.07	73.25
2S2XA	170	67	97 - 157	38 - 62	54	21	99	39	49	19	91	200	1.63	57.65
1S1X	103	41	97 - 157	38 - 62	54	21	99	39	49	19	75	166	0.99	34.93
2.5EL1XA, 2.5ER1XA	190	75	97 - 157	38 - 62	54	21	99	39	49	19	99	219	1.82	64.43
2EL1XA, 2ER1XA	144	57	97 - 157	38 - 62	54	21	99	39	49	19	75	166	1.38	48.83
1.5EL1X, 1.5ER1X	108	43	97 - 157	38 - 62	54	21	99	39	49	19	58	128	1.04	36.63
1EL1X, 1ER1X	85	33	97 - 157	38 - 62	54	21	99	39	49	19	46	102	0.82	28.83
3EL, 3ER	206	81	97	38	54	21	99	39	49	19	71	157	1.98	69.86
2.5EL, 2.5ER	191	75	97	38	54	21	99	39	49	19	66	145	1.83	64.77
2EL, 2ER	146	57	97	38	54	21	99	39	49	19	50	111	1.40	49.51
1EL, 1ER	85	33	97	38	54	21	99	39	49	19	29	65	0.82	28.83
2NA	121	48	97	38	54	21	99	39	49	19	39	86	1.16	41.03
1NA	59	23	97	38	54	21	99	39	49	19	26	58	0.57	20.01
STA	32	13	97	38	54	21	99	39	49	19	19	42	0.31	10.85
SQC	110	43	110	43	-	-	99	39	49	19	44	97	1.20	42.30
C	123	48	123	48	54	21	99	39	49	19	38	84	1.50	52.89
COUL, COUR	102	40	160	63	115	45	99	39	49	19	53	117	1.62	57.06
1ELTC, 1ERTC	222	87	110	43	-	-	99	39	49	19	73	161	2.42	85.38
1ELT, 1ERT	112	44	97	38	54	21	99	39	49	19	38	83	1.08	37.98
1ELST, 1ERST														
1.5ELST, 1.5ERST	134	53	97	38	54	21	99	39	49	19	45	100	1.29	45.44
1.5ELT, 1.5ERT														
3S	230	91	97	38	54	21	99	39	49	19	75	166	2.21	78.00
2.5S	215	85	97	38	54	21	99	39	49	19	70	155	2.06	72.91
2S	172	68	97	38	54	21	99	39	49	19	56	124	1.65	58.33
AC	105	41	97	38	54	21	99	39	49	19	40	89	1.01	35.61
RFSTA	80	31	60	24	-	-	-	-	48	19	13	29	0.23	8.14

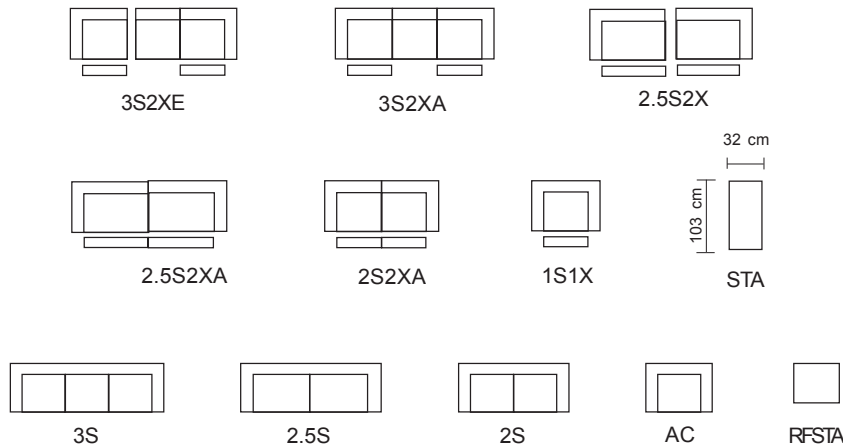
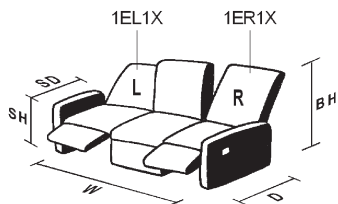

**CONSTRUCTION**

- ⇒ **SEAT** : No-sag Spring
- ⇒ **BACK REST** : Rubber Webbing
- ⇒ **SEAT CUSHION** : D/38S + D/22
- ⇒ **BACK REST CUSHION** : Loose Fibre
- ⇒ **SOFA LEGS** (front & rear) :
  - code : WLG-513-27L / WLG-212-27L / WLG-276-27L /  
PLG-005-01L / PLG-046-01L
  - material : Wooden / Plastic
  - height : 50mm (WLG-513-27L, WLG-212-27L, WLG-276-27L,  
PLG-005-01L)
  - : 40mm (PLG-046-01L)
  - colour : 27 = Wenge / 01 = Black

\* Available in MANUAL (X), ELECTRIC (V), BATTERY (B) Versions.

\* Support Leg

36 COMBINATIONS

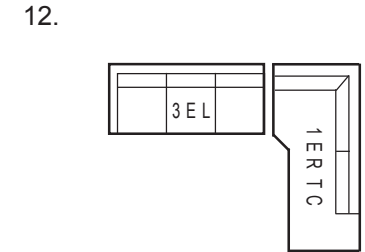
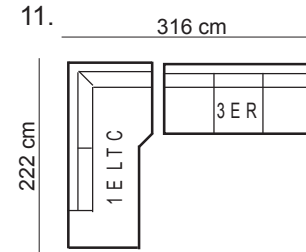
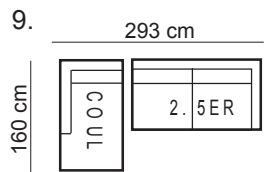
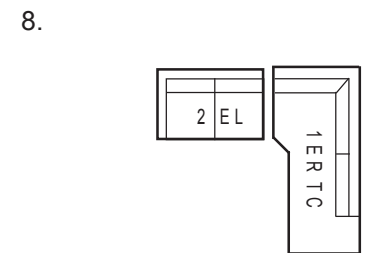
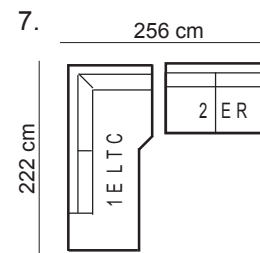
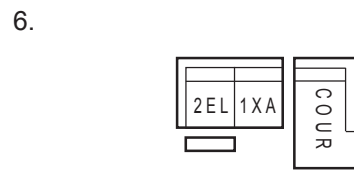
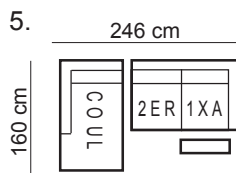
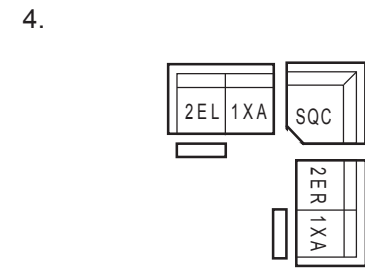
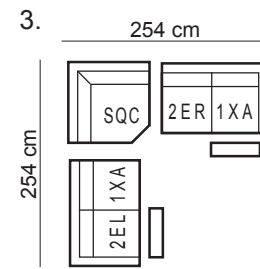
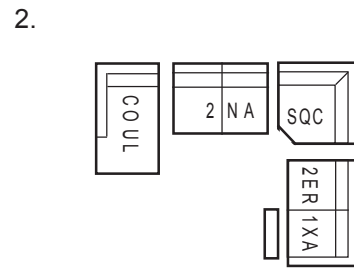
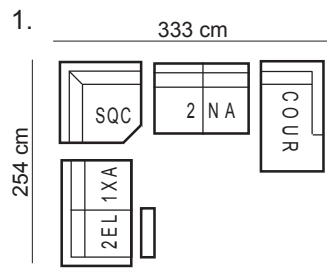

# HTL - 2743 #369

## 36 COMBINATIONS

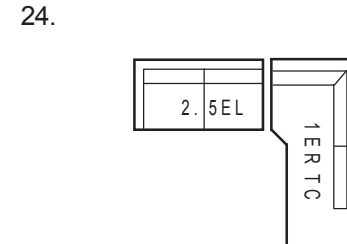
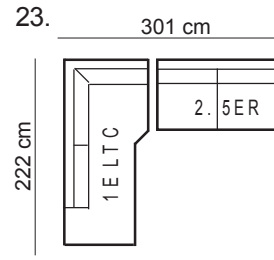
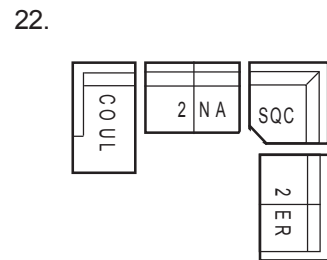
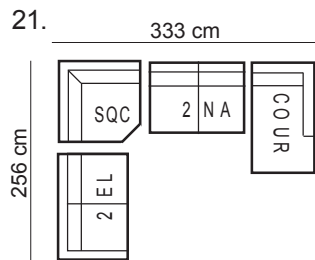
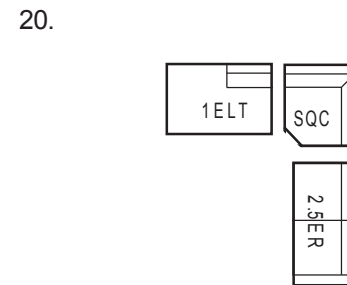
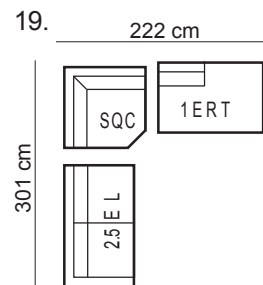
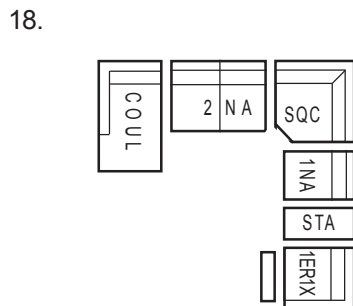
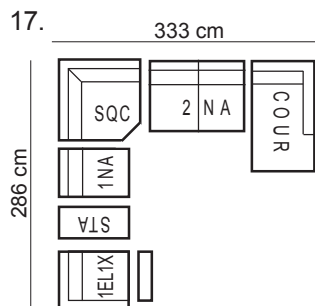
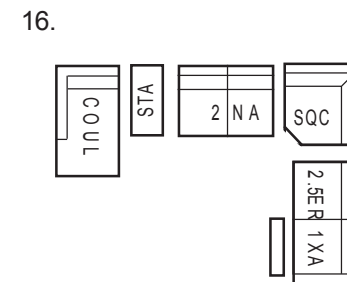
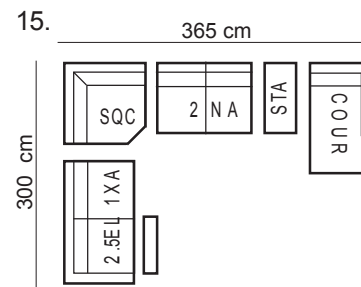
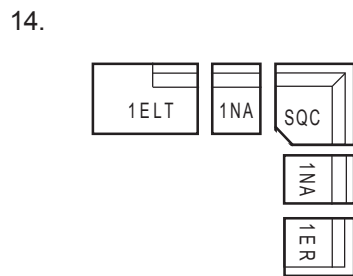
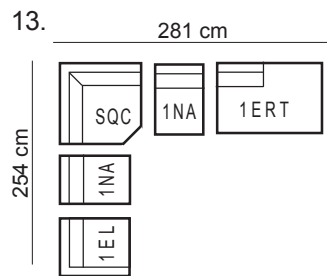



# HTL - 2743 #369

## 36 COMBINATIONS

